

SHARP

SERVICE MANUAL

维修手册

S35L814HSC///

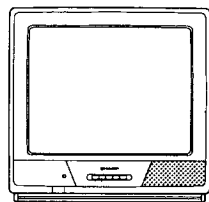

14H-SC

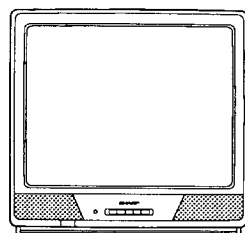

21H-SC

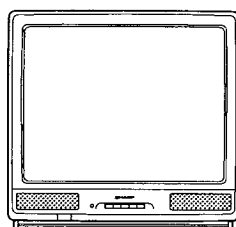

20H-SC

COLOUR TELEVISION

彩色电视机

Chassis No. H

14H-SC

20H-SC

21H-SC

MODELS
型号

In the interests of user-safety (Required by safety regulations in some countries) the set should be restored to its original condition and only parts identical to those specified should be used.

为了用户安全起见(根据一些国家的安全规程的需要), 应将电视机保持于最初的状态, 而且只能使用与指定物相同的部件。

FEATURE

- Reminder/ON-OFF Timer
- English/Arabic/Chinese Three Language OSD
- High Sensitivity Tuner
- Wide Range Chopper Regulator System
- AV Input/Output Terminal
- Blue Back
- PAL/SECAM Dual System
- NTSC 4.43/3.58MHz (AV only)
- Direct Access Remote Control

主要功能

- 提醒功能/定时自动开机-关机功能
- 在屏英文/阿拉伯文/中文三种语言表示功能
- 高灵敏度调谐器
- 宽频带削波调整系统
- 声象信号输入/输出插孔
- 蓝色背景功能
- PAL/SECAM制式兼容
- NTSC 4.43/3.58MHz(只限于声象信号输入)
- 遥控器直接存取功能

WARNING

The chassis in this receiver is partially hot. Use an isolation transformer between the line cord plug and power receptacle, when servicing this chassis. To prevent electric shock, do not remove cover. No user — serviceable parts inside. Refer servicing to qualified service personnel.

警告

该电视机底盘的有些部分通电。当维修本机底盘时, 请在电源线插头和电源插座之间使用隔离变压器。为了防止电击的危险, 不要去拆下机盖。在里面的部件, 不是使用者所能维修的, 必须委托够格的维修人员进行维修。

SHARP CORPORATION

CONTENTS

	Page
● SPECIFICATIONS	3
● IMPORTANT SERVICE NOTES	4
● SERVICE ADJUSTMENT	5
● TROUBLE SHOOTING TABLE	14
● CHASSIS LAYOUT	18
● SOLID STATE DEVICE BASE DIAGRAM	20
● BLOCK DIAGRAM	21
● PRINTED WIRING BOARD ASSEMBLIES	25
● WAVEFORMS	33
● SCHEMATIC DIAGRAM	
■ TUNER	34
■ REMOTE CONTROL UNIT	34
● DESCRIPTION OF SCHEMATIC DIAGRAM	35
● REPLACEMENT PARTS LIST	
■ ELECTRICAL PARTS	36
■ SUPPLIED ACCESSORIES	47
■ PACKING PARTS	47
■ CABINET PARTS	48

目 录

	页
● 规格	3
● 维修注意事项	4
● 保养调试	5
● 故障检修表	14
● 机底板电路图	18
● 固态部件基座图	20
● 整体方框图	21
● 印刷电路板的组装件	25
● 波形图	33
● 电路原理图	
■ 调谐器	34
■ 遥控器	34
● 电路原理图的说明	35
● 更换零件表	
■ 电路零件	36
■ 附属品	47
■ 包装部件	47
■ 机壳零件	48

SPECIFICATIONS

Convergence	Self Converging System
Focus	Quadra-Potential Electrostatic
Sweep Deflection	Magnetic
Intermediate Frequencies	38.9 MHz
Picture IF Frequency	32.4 MHz
Sound IF Carrier Frequency	32.9 MHz
6.5 MHz	33.4 MHz
6.0 MHz	34.47 MHz
5.5 MHz	
Colour Sub-Carrier Frequency	
Power Input	110—240V AC 50/60 Hz
Power Consumption	
14H-SC	59W
20H-SC	87W
21H-SC	88W
Audio Power Output Rating	3.0W (at Max.)
Speaker	
Size	5 cm x 9 cm x 2 pcs
Voice Coil Impedance	16 ohms at 400Hz
Aerial Input Impedance	
VHF/UHF	75 ohm Unbalanced
Receiving System	GCIR/SECAM/PAL B, G, D, K, I
NTSC 3.58/4.43 MHz (AV Input Only)	
Tuning Ranges	
• VHF- Channels	E2 (48.25 MHz) thru E12 (224.25 MHz)
C1 (49.75 MHz) thru C12 (216.25 MHz)	
S1 (105.25 MHz) thru S20 (299.25 MHz)	
• UHF- Channels ..	E21 (471.25 MHz) thru E69 (855.25 MHz)
C13 (471.25 MHz) thru C57 (863.25 MHz)	
Dimensions	
14H-SC	Width: 361 mm
Height: 348 mm	
Depth: 365 mm	
Weight (approx.)	10 kg
20H-SC	Width: 496 mm
Height: 464 mm	
Depth: 481 mm	
Weight (approx.)	19 kg
21H-SC	Width: 496 mm
Height: 463 mm	
Depth: 471 mm	
Weight (approx.)	21 kg
Cabinet Material	All Plastics

Specifications are subject to change without prior notice.

规格

聚焦	自聚焦系统
焦点	平方电位静电聚焦
扫描偏转	磁致偏转
中频	
图像中频载波频率	38.9MHz
声音中频载波频率	
6.5MHz	32.4MHz
6.0MHz	32.9MHz
5.5MHz	33.4MHz
彩色副载波频率	34.47MHz
电源	交流110~240V, 50/60Hz
功率消耗	98W
型号14H-SC	59W
型号20H-SC	87W
型号21H-SC	88W
音响额定输出功率	3.0W(最大)
扬声器	
尺寸	5cm x 9cm x 2只
音圈阻抗	16Ω (400Hz时)
天线输入阻抗	
甚高频(VHF)/超高频(UHF)	75Ω非平衡式
接收制式	GCIR, SECAM, PAL B, G, D, K, I
NTSC 3.58/4.43MHz (只限于声音信号输入)	
调谐范围	
• 甚高频(VHF)频道	
E2(48.25MHz)至E12(224.25MHz)	
C1(49.75MHz)至C12(216.25MHz)	
S1(105.25MHz)至S20(299.25MHz)	
• 超高频(UHF)频道	
E21(471.25MHz)至E69(855.25MHz)	
C13(471.25MHz)至C57(863.25MHz)	
尺寸	
型号14H-SC 型号20H-SC 型号21H-SC	
宽	361mm 496mm 496mm
高	348mm 464mm 463mm
深	365mm 481mm 471mm
重量(大约) ...	10kg 19kg 21kg
机壳	均由塑料而成

上述规格变更之场合, 恕不另行通知。

SERVICE ADJUSTMENT

PIF/AFT/AGC ADJUSTMENT

Adjusting Conditions

Adjusting Procedures

1. Tuner IFT Coils

The tuner has been factory preset (no adjustment is needed).

1. Receive VHF high channel (channel-E10) (When such signal is not available, set V_H voltage at 5V in V_H band.)
2. Connect sweep generator's output to the test point of tuner, by using a 75Ω DC cut probe.

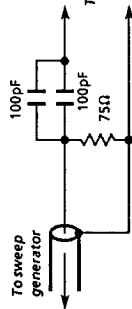

Connection Diagram of 75Ω DC Cut Probe.

Note: The sweep generator's probe should be grounded closely to the tuner test point.

3. Output level of sweep generator: 85 dB
4. Connect response lead (low impedance probe with detector) to TP201 (collector of Q201).

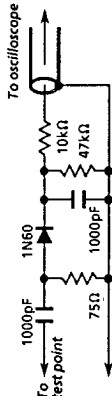

Connection Diagram of Low Impedance Probe (with Detector).

5. PIF AGC: Apply DC 4V to TP202 (pin (48) of IC801).
6. RF AGC: Apply DC 4V to the tuner AGC terminal.

1. Adjust the tuner IF coils to obtain the waveform as shown figure below.

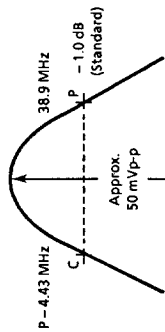

Adjust so that "P" and "C" are at the same level.

保养调试

PIF/AFT/AGC的调试

调试条件

调试方法

1. 调整IF线圈

该调谐器出厂前已作预调(无重新调试之必要)

1. 接收VHF高频(频道E10)信号(电视机在无线号接收状态时, 设 V_H 电压于 V_H 频带的5V)。
2. 用75Ω直流截断探针电路, 将扫频发生器输出端连接于调谐器的测试点。

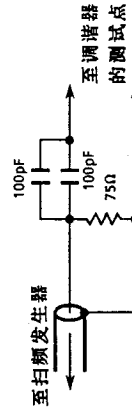

75Ω直流截断探针电路连接图

注意: 扫频发生器的接地线必须接地于测试点附近。

3. 扫频输出电平: 85db。
4. 连接响应引线(检测器的低阻抗探针)于TP201 (Q201集电极)。

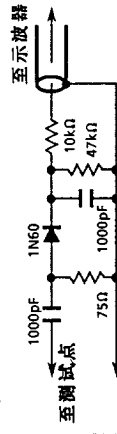

低阻抗探针(带检测器)电路连接图

5. PIF AGC电压设定: 加4V直流电压于TP202 (IC801的脚(48))。
6. RF AGC电压设定: 加4V直流电压于调谐器AGC连接端。

1. 调整调谐器IF线圈, 以获得下图所示输出波形。

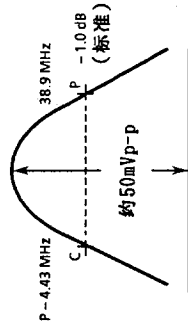

检查“P”及“C”两点是否于相同的电平线上

PIF/AFT/AGC ADJUSTMENT (Continued)

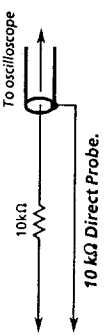
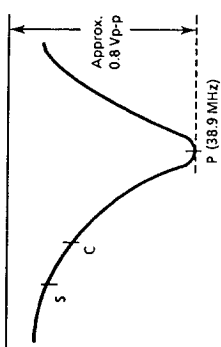
Adjusting Procedures	
<p>2. P-Detector Adjustment</p> <p>Adjusting Point □ T205: P-Detector coil</p> <ol style="list-style-type: none"> Connect sweep generator's output to TP203 (pin (46) of IC801). Probe in use: 75Ω DC cut probe Sweep output level: 90 dB PIF AGC: Apply 4V DC to TP202 (pin (48) of IC801). Have AFT muted (by pressing the preset key to bring in the SEARCH mode). Connect response lead to pin (7) of IC801. The response lead in use should be a direct probe with a resistor of 10 kΩ included. 	 <p>1. Adjust T205 so that 38.9 MHz signal is at maximum (± 50 kHz).</p> <p>* Adjust PIF AGC voltage so that the output waveform is of approx. 0.8 Vp-p.</p>

PIF/AFT/AGC的调试(接上页)

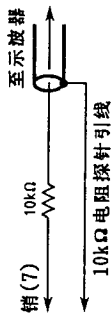
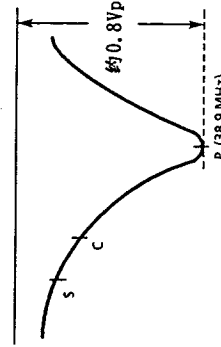
调试方法	
<p>2. P-检波器信号的调试</p> <p>调试点 □ T205: P-检波器线圈</p> <ol style="list-style-type: none"> 连接扫频发生器输出端于TP203 (IC801的销(46))。 <ul style="list-style-type: none"> 使用探针: 75Ω 直流截断探针 扫频发生器输出端电平: 90dB PIF AGC电压设定: 加4V 直流电压于TP202 (IC801的销(48))。 置AFT于静音状态(触按预设键,使电视机处搜索台状态即可)。 连接响应引线于IC801的销(7)。该响应引线应为具有10kΩ电阻的探针。至示波器 	 <p>1. 调节T205,使其信号最大值为38.9MHz (± 50kHz)</p> <p>*调节PIF AGC电压使其输出电平约达0.8Vp-p.</p>

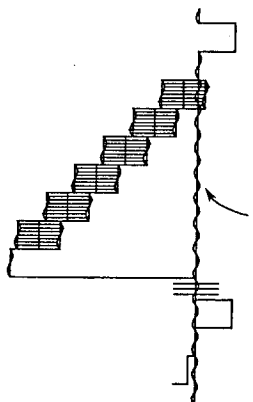
<p>3. AFT Adjustment</p> <p>Adjusting Point □ T205: AFT coil</p> <ol style="list-style-type: none"> Receive VHF high channel (channel-E12). Signal strength: Over 55dB, Below 80dB Connect the Regulated DC Power Supply to the tuner's V_T (approx. 6V to be applied) to receive channel-E12. Connect oscilloscope to TP401. <ul style="list-style-type: none"> Oscilloscope range: 0.5 V/div. Sweep time: 20 μsec/div. Synchronization: Horizontal sync. Connect the output of SSG (Standard Signal Generator) to the tuner IF output terminal across a capacitor of 1pF. <ul style="list-style-type: none"> SSG output: 38.9 MHz \pm 5 kHz (non modulated) SSG output level: approx. 85 dB <p>* When the preset button is at PRESET position, AFT is turned off.</p> <p>* Preset button is set at NORMAL position, AFT is turned on.</p>	<p>Fine Adjustment</p> <ol style="list-style-type: none"> Press the preset key to adjust the voltage of the Regulated DC Power Supply until there is no beating in the oscilloscope's waveform. Set the preset button at NORMAL position. Adjust T205 so that no beating is caused at the output waveform. 
---	--

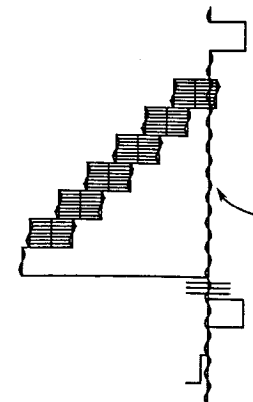
<p>3. AFT 调试</p> <p>调试点 □ T205: AFT线圈</p> <ol style="list-style-type: none"> 接收VHF高频(频道E12)信号。 <ul style="list-style-type: none"> 信号强度: 大于55dB, 小于80dB 接直流电源于调谐器V_T端(约加直流电压6V),以接收频道E12的信号。 将示波器和TP401相接。 <ul style="list-style-type: none"> 示波器测试范围: 0.5伏/度 扫描时间: 20微秒/度 同步动作: 水平同步 通过1pF电容器,并连接标准信号发生器(SSG)的输出端与调谐器的IF输出端。 <ul style="list-style-type: none"> SSG输出频率: 38.9MHz \pm 5kHz(无调制) SSG输出电平: 约85dB <p>* 预设键处于PRESET位置时, AFT关闭。</p> <p>* 预设键处于NORMAL位置时, AFT接通。</p>	<p>微调</p> <ol style="list-style-type: none"> 触按预设键,调节直流电源电压,直至示波器上的输出波形表面无差拍出现。 设预设键于NORMAL位置处。 调节T205,使示波器上的输出波形无差拍出现为止。  <p>调节微调使其差拍为零</p>
--	---

PIF/AFT/AGC的调试(接上页)

调试条件

4. PIF全波形的调试

- 接收VHF高频(频道E10)信号。
电视机在无该信号接收状态时,设V_r电压于V_H频带的5V。
将扫频发生器输出端与调谐器测试点连接。
● 使用探针: 75Ω直流截断探针
● 扫频发生器输出电平: 90dB
- 连接响应引线于IC801的销(7)。
该响应引线应具有10kΩ电阻的探针。
- RF AGC电压设定:
加约4V直流电压于调谐器的AGC连接端。
- PIF AGC电压设定:
加约4V直流电压于TP202。
- 用120Ω的阻尼电阻与R215并连接,然后将C244短路。
- 关闭AFT。

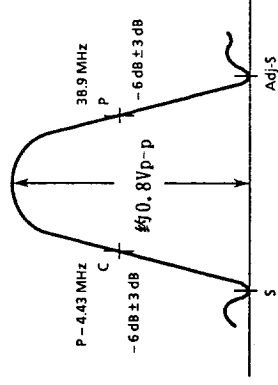

- 调节IF AGC电压,使其输出电压达至0.8Vp-p左右。
- 确认所得全波形轮廓如下图所示。

PIF/AFT/AGC ADJUSTMENT (Continued)

Adjusting Procedures

4. PIF Overall Adjustment

- Receive VHF high channel (channel-E10). If channel-E10 signal is not available, set V_r voltage at 5V in V_H band.
- Connect sweep generator's output to the test point of tuner.
● Probe in use: 75Ω DC cut probe
● Sweep output level: 90 dB
- Connect response lead to pin (7) of IC801. The response lead in use should be a direct probe with a resistor of 10kΩ included.
- RF-AGC:
Apply approx. 4V DC to the tuner AGC terminal.
- PIF AGC:
Apply approx. 4V DC to TP202.
- Connect a 120Ω damping resistor in parallel to R215, short C244.
- Turn off AFT.

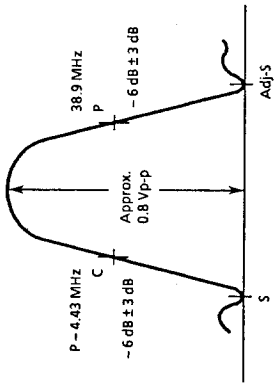

- Adjust IF AGC voltage so that the output waveform is of approx. 0.8Vp-p.
- Check that the overall waveform is as shown in Figure below.

5. RF-AGC Cut-in Adjustment

Adjusting Point

□ R248: RF-AGC control

- Keep the AGC Cut-in control near the center position.
- Receive VHF high channel (channel-E12).
● Signal strength: 54dB ± 1 dB (with 50Ω open)
- Connect the oscilloscope to the tuner's AGC terminal (TP210).
● Range: DC range
● Voltage: 100 mV/div.
● Sweep: 10 msec/div.
* Set the Regulated DC Power Supply to approx. 6.0V and turn up the oscilloscope range to 10mV (DC).

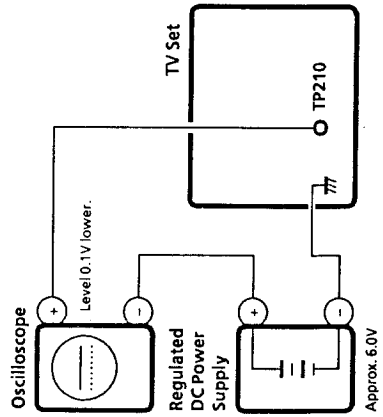

- Turn R248 to obtain the highest voltage.
- Turn R248 slowly in the opposite direction until the voltage drops 0.1V lower than the highest level.
- Change the antenna input signal to 65dB ± 2dB and make sure there is no noise. Turn up the input signal to 90 — 95dB to be sure that there is no cross-modulation beat.

4. PIF全波形的调试

- 接收VHF高频(频道E10)信号。
电视机在无该信号接收状态时,设V_r电压于V_H频带的5V。
将扫频发生器输出端与调谐器测试点连接。
● 使用探针: 75Ω直流截断探针
● 扫频发生器输出电平: 90dB
- 连接响应引线于IC801的销(7)。
该响应引线应具有10kΩ电阻的探针。
- RF AGC电压设定:
加约4V直流电压于调谐器的AGC连接端。
- PIF AGC电压设定:
加约4V直流电压于TP202。
- 用120Ω的阻尼电阻与R215并连接,然后将C244短路。
- 关闭AFT。

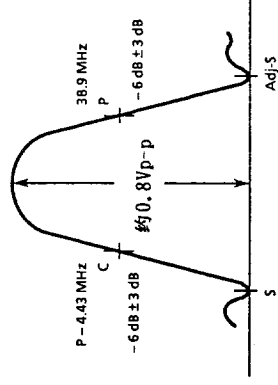

- 调节IF AGC电压,使其输出电压达至0.8Vp-p左右。
- 确认所得全波形轮廓如下图所示。

5. RF-AGC接通的调试

调试点

□ R248: RF-AGC控制

- 设AGC接通控制于其中央近旁之位置处。
- 接收VHF高频(频道E10)信号。
● 信号强度: 54dB ± 1dB (端接50Ω电阻)。
- 连接示波器于调谐器AGC连接端(TP210).
● 测定电压: 直流范围
● 电压范围: 1V/段
● 扫描时间: 10毫秒/段
* 设直流稳压电源电压于6.0V左右, 调示波器测试范围至0.1V/段。

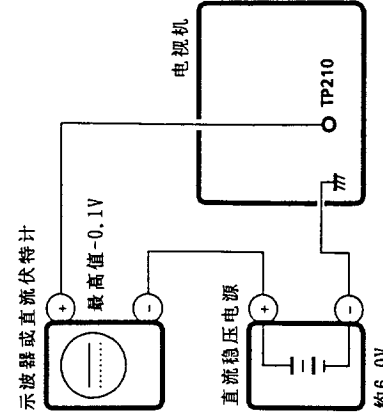

- 旋转R248,使伏特计读数达至最高。
- 反方向缓慢旋转R248,让伏特计读数为最大值-0.1V。
- 将天线输入信号电平调至65dB ± 2dB,并确认其信号输出不带噪声。然后将输入信号电平调至90~95dB,并确认其信号输出波形不带交叉调制拍频。

115V LINE ADJUSTMENT

Adjusting Conditions	Adjusting Procedures
<p>Adjusting Point □ R711: 115V Adjustment Control</p> <ol style="list-style-type: none"> Set the R711 to 5/10 before supplying power. Receive "MONOSCOPE PATTERN (channel-E5)" signal. Set Contrast and Brightness controls at MAX position. Connect DC milliammeter to TP602⊖ and TP603⊕. 14H-SC: Using the DC milliammeter, check to see that the beam current is between 600 and 800 μA. 20H-SC, 21H-SC: Using the DC milliammeter, check to see that the beam current is between 900 and 1100 μA. <p>Note: In other cases than the above, adjust the R420 Sub-Contrast control.</p> <ol style="list-style-type: none"> Connect Digital voltmeter to TP701. 	<ol style="list-style-type: none"> Adjust the R711 until the TP701's voltage becomes 115 ± 0.5V.

VIDEO/CHROMA ADJUSTMENT

Adjusting Conditions	Adjusting Procedures
<p>Adjusting Point □ R853: Red Bias control □ R859: Green Bias control □ R865: Blue Bias control □ T602: Screen control (a part of T602) □ R857: Green Drive control □ R863: Blue Drive control</p> <p>Note: Prior to this adjustment, warm up the unit with the beam current of more than 500 μA (14H-SC), 700 μA (20H-SC, 21H-SC) for more than 30 minutes.</p> <ol style="list-style-type: none"> Receive "MONOSCOPE PATTERN (channel-E5)" signal. Make the picture normal. Set Brightness control at 5/10 position and Contrast control at MIN position. Set Red bias control at MIN position. Set Green bias control at MIN position. Set Blue bias control at MIN position. Set Green drive control at CENTER position. Set Blue drive control at CENTER position. Using the remote controller, call the AV mode (no signal). Short TP501. 	<ol style="list-style-type: none"> Slowly turn the Screen control clockwise until the horizontal raster appears slightly, and stop it. Here, one of the three colours (red, blue, green) appears first as the Screen control is turned. So, touching off the Bias control belonging to the first colour, use and move the other two controls so that the horizontal raster becomes white. Turn the Screen control counterclockwise until the horizontal raster disappears, and stop it.

115V线路调试

调试条件	调试方法
<p>调试点 □ R711: 115V线路调试控制</p> <ol style="list-style-type: none"> 输入电源前, 先设R711于中央(5/10)位置。 接收“单象管图案(频道E5)”信号。 设对比度控制和亮度控制于其最大(MAX)位置。 接直流毫安表于TP602⊖和TP603⊕。(测试范围: 3mA) 型号14H-SC: 用直流毫安表检查电流是否于600~800 μA之间。 型号20H-SC和21H-SC: 用直流毫安表检查电流是否于900~1100 μA之间。 <p>注: 上述之外之场合, 调试副对比度控制(R420)。</p> <ol style="list-style-type: none"> 接数值伏特计于TP701。 	<ol style="list-style-type: none"> 调节R711, 使TP701的电压达至115V ± 0.5V。

视频/色度信号电路的调试

调试条件	调试方法
<p>调试点 □ R853: 红色偏转控制 □ R859: 绿色偏转控制 □ R865: 蓝色偏转控制 □ T602: 画面控制(T602的一部分) □ R857: 绿色激励控制 □ R863: 蓝色激励控制</p> <p>注意: 作此项调试前, 先用500 μA以上(型号14H-SC)或700 μA以上(型号20H-SC和21H-SC)的电子束电流为电视机预热30分钟以上。</p> <ol style="list-style-type: none"> 接收“单象管图案(频道E5)”信号。 设电视机画面于标准画面状态。 设亮度控制于5/10位置, 设对比度控制于10/10位置。 设红色偏转控制于最小(MIN)位置。 设绿色偏转控制于最小(MIN)位置。 设蓝色偏转控制于最小(MIN)位置。 设绿色激励控制于中心(CENTER)位置。 设蓝色激励控制于中心(CENTER)位置。 设画面控制于最小(MIN)位置。 用遥控器呼出AV方式(无信号)。 短接TP501。 	<ol style="list-style-type: none"> 顺时针方向缓慢地旋转画面控制旋钮, 直至荧屏上微弱地出现水平光栅为止。 画面控制的调节, 最初出现的水平光栅泛红、绿、蓝三色之一。这时, 对最初出现的色彩控制不作调节, 而对另外两色色彩的控制作顺时针方向的调节, 荧屏上的水平光栅会变为白色。 反时针方向旋转画面控制旋钮, 直至荧屏上的水平光栅完全消失为止。

VIDEO/CHROMA ADJUSTMENT (Continued)

Adjusting Conditions	Adjusting Procedures
<p>2. White Balance and Back Ground Adjustment</p> <p>Adjusting Point <input type="checkbox"/> R857: Green Drive control <input type="checkbox"/> R863: Blue Drive control <input type="checkbox"/> R420: Sub-Contrast control</p> <p>Note: Prior to this adjustment, warm up the unit with the beam current of more than 500μA (14H-SC), 700μA (20H-SC, 21H-SC) for more than 30 minutes.</p>	<p>1. Adjust Sub-Contrast control so that the beam current becomes 800 μA (14H-SC) / 1.1mA (20H-SC, 21H-SC) (rough adjustment)</p> <p>2. Adjust Green Drive control and Blue Drive control so that the colour temperature is at 10900°K. (High beam: 800 μA (14H-SC) / 1.1mA (20H-SC, 21H-SC)).</p> <p>3. Adjust the Contrast control and Brightness control so that the beam current is approx. 200μA, and check that the colour temperature is at 10900°K. If the temperature is not at 10900°K, go back to "CRT CUT-OFF ADJUSTMENT" and repeat the adjustment.</p>

3. Sub-Contrast Adjustment

<p>Adjusting Point <input type="checkbox"/> R420: Sub-Contrast control</p> <p>Note: Prior to this adjustment, warm up the unit with the beam current of more than 500μA (14H-SC), 700μA (20H-SC, 21H-SC) for more than 30 minutes.</p>	<p>1. Adjust Sub-Contrast control so that the beam current becomes 800 μA (14H-SC) / 1.1mA (20H-SC, 21H-SC).</p>
---	---

DEFLECTION LOOP ADJUSTMENT

Adjusting Conditions	Adjusting Procedures
<p>1. Horizontal Centering Adjustment</p> <p>Adjusting Point <input type="checkbox"/> R613: Horizontal Centering control</p> <p>Note: This adjustment should be performed after the purity and convergence adjustments.</p>	<p>1. Adjust R613 so that the horizontal center of picture is at the position which gives the relation of A=B.</p>

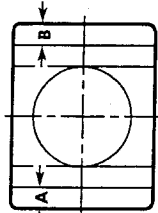

视频/色度信号电路的调试(接上页)

调试条件	调试条件
<p>2. 白色平衡及底色的调试</p> <p>调试点 <input type="checkbox"/> R857: 绿色激励控制 <input type="checkbox"/> R863: 蓝色激励控制 <input type="checkbox"/> R420: 副对比度控制</p> <p>注意: 作此项调试前, 先用500μA以上(型号14H-SC)或700μA以上(型号20H-SC和21H-SC)的电子束电流为电视机预热30分钟以上。</p>	<p>1. 调节副对比度控制, 使电子束电流达至800μA(型号14H-SC)或1100μA(型号20H-SC和21H-SC)(粗调)。</p> <p>2. 调节绿色激励控制和蓝色激励控制, 使色温达至10900°K。</p> <p>3. 调节副对比度控制(高电子束: 800μA(型号14H-SC)或1100μA(型号20H-SC和21H-SC))。</p> <p>4. 调节对比度控制和亮度控制, 使电子束电流达至200μA左右。然后, 检查色温是否为10900°K。如果这时的色温并非10900°K, 则必须回到“CRT切断调试”, 并重复此项调试。</p>

3. 副对比度的调试

<p>调试点 <input type="checkbox"/> R420: 副对比度控制</p> <p>注意: 作此项调试前, 先用500μA以上(型号14H-SC)或700μA以上(型号20H-SC和21H-SC)的电子束电流为电视机预热30分钟以上。</p>	<p>1. 调节副对比度控制, 使电子束电流达至800μA(型号14H-SC)或1100μA(型号20H-SC和21H-SC)。</p>
--	--

检波回路的调试

调试条件	调试方法
<p>1. 水平对中调试</p> <p>调试点 <input type="checkbox"/> R613: 水平对中调节</p> <p>注意: 此项调试应在色彩纯度和画面聚焦度调试之后进行。</p>	<p>1. 调节R613, 使荧光屏图像水平中心位置达至如图所示的A=B之程度。</p>

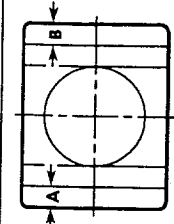

DEFLECTION LOOP ADJUSTMENT (Continued)

Adjusting Conditions	Adjusting Procedures
<p>2. Vertical Size Adjustment</p> <p>Adjusting Point <input type="checkbox"/> R509: Vertical Size control</p> <p>1. Receive "MONOSCOPE PATTERN (channel-E5)" signal. 2. Set the Brightness and Contrast controls at MAX position.</p>	<p>1. Adjust R509 so that the vertical size of picture is at the best point. ● Vertical size: 8% TYP (Max. 10%, Min. 6%)</p>
<p>3. Vertical Linearity Adjustment (Only for models 20H-SC and 21H-SC)</p> <p>Adjusting Point <input type="checkbox"/> R514: Vertical Size control</p> <p>1. Receive "MONOSCOPE PATTERN (channel-E5)" signal.</p>	<p>1. Adjust R514 so that the vertical linearity of picture is at the best point.</p>
<p>4. Vertical Center Adjustment (Only for models 20H-SC and 21H-SC)</p> <p>Adjusting Point <input type="checkbox"/> R501: Vertical Center Adjust switch</p> <p>Note: This adjustment should be performed after the purity and convergence adjustments.</p> <p>1. Receive "MONOSCOPE PATTERN (channel-E5)" signal.</p>	<p>1. Adjust R501 so that the vertical center of picture is at the best point.</p>

检波回路的调试(接上页)

调试条件	调试方法
<p>2. 垂直尺寸的调整</p> <p>调试点 <input type="checkbox"/> R509: 垂直尺寸调节 1. 接收“单象管图案(频道E5)”信号。 2. 设亮度控制和对比度控制于其最大(MAX)位置。</p>	<p>1. 调节R509, 以获得荧屏图案的最佳垂直尺寸。 ● 垂直尺寸: 8% TYP(最大10%, 最小6%)</p>
<p>3. 垂直线性度调整(只限于型号20H-SC和21H-SC)</p> <p>调试点 <input type="checkbox"/> R514: 垂直尺寸控制 1. 接收“单象管图案(频道E5)”信号。</p>	<p>1. 调节R514, 使画面的垂直线性度达至最佳状态。</p>
<p>4. 垂直中心调整(只限于型号20H-SC和21H-SC)</p> <p>调试点 <input type="checkbox"/> S501: 垂直中心控制开关 注意: 此项调试应在色彩纯度和画面聚焦度调试之后进行。 1. 接收“单象管图案(频道E5)”信号。</p>	<p>1. 调节S501, 使画面的垂直中心位置达到最佳状态。</p>

FOCUS ADJUSTMENT

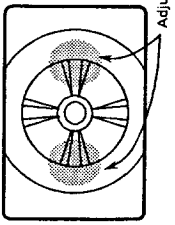
Adjusting Conditions	Adjusting Procedures
<p>Adjusting Point <input type="checkbox"/> T602: Focus control (a part of T602)</p> <p>1. Receive "MONOSCOPE PATTERN (channel-E5)" signal. 2. Set Contrast control at NORMAL position. 3. Set Brightness control at MAX position. (Instead of monoscope pattern signal, it is allowed to use white pattern signal of 88% modulation.)</p>	<p>1. Adjust Focus control to have best focus at the central area of CRT.</p> 

聚焦的调试

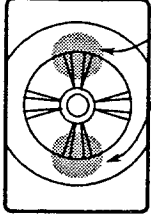
调试条件	调试方法
<p>调试点 <input type="checkbox"/> T602: 聚焦控制 (T602的一部分) 1. 接收“单象管图案(频道E5)”信号。 2. 设对比度控制于标准(NORMAL)位置。 3. 设亮度控制于其最大(MAX)位置(电子泵电流(无单象管图案信号时,可用88%调制的白色图案信号代替之))</p>	<p>1. 调节聚焦控制, 使荧屏中心位置达至最佳聚焦效果。</p> 

CRT DISPLAY ADJUSTMENT

Adjusting Procedures

1. Sign Position Adjustment

Adjusting Point

□ T1001: Sign Position check (T1001 preset)

* Make this adjustment after the H-CENT adjustment.

1. Receive "MONOSCOPE PATTERN (channel-E5)" signal.

2. Press the P-MODE key on the remote controller to make the DAC center bar appear on the screen.

(COLOUR, BRIGHT, TINT)

1. Make sure that the DAC center bar is at the geometrical center of the monoscope pattern. If 0.5 line or more away from the geometrical center, readjust T1001.

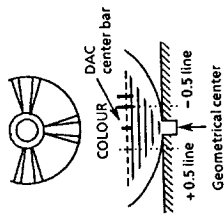

CRT显示的调试

调试方法

调试条件

1. 文字信号表示位置的调试

调试点

□ T1001: 文字信号显示位置控制(T1001预调)

* 此项调试应在水平中心调试之后进行。

1. 接收“单象管图案(频道E5)”信号。

2. 触摸遥控器上的P-MODE键,使DAC中心条显示在画面上。(彩色、亮度、色调)

1. 检查单象管图案的几何中心处有无DAC中心条。如果与几何中心偏离0.5条,就用T1001来进行重调。

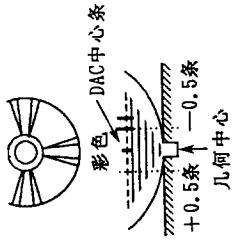

PURITY ADJUSTMENT

Adjusting Conditions

1. Prior to the purity adjustment, warm up the unit with beam current of more than 500 μ A (14H-5C) / 700 μ A (20H-5C, 21H-5C), for more than 30 minutes.
2. Receive the green signal alone and adjust the beam current to approx. 500 μ A (14H-5C) / 700 μ A (20H-5C, 21H-5C).
3. Fully degauss the CRT with the degaussing coil.
4. Before the purity adjustment, it is needed to roughly adjust the static convergence.
5. Set the purity magnet at the position which gives

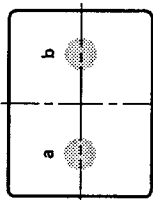
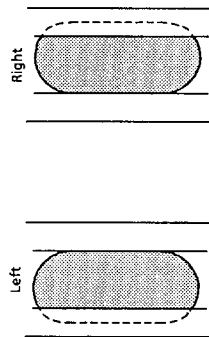
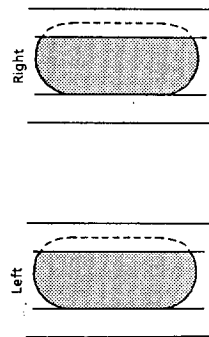

Figure A.



The beam landing is shifted outwards.

Figure B.



The beam landing is shifted to right.

Figure C.

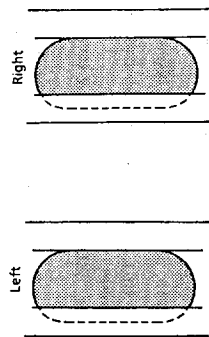

The beam landing is shifted to left.

Figure D.

Adjusting Procedures

Adjustment:
During the adjustment, keep the unit facing the east.

1. Observe the green spots ("a" and "b") with a microscope as shown in Fig. A, and adjust the purity magnet so that they are at the specified landing position.
 2. If the right and left green spots are both deviated outwards from their landing positions as shown in Fig. B, push the deflection yoke forwards until their positions are corrected.
 3. If the beam landing is shifted to right or left as shown in Figs. C and D, adjust the opening degree of the purity magnet so that the beam landing is correctly positioned.
 4. Adjust the purity magnet so that the beam landing is correct at either of the central part, right and left parts of screen, then check that the green beams at four corners of screen are all correctly positioned.
- Finally, check that the beam landing at any part of screen is satisfactory with the Rank "B" specifications.
5. If the green beam is positioned to mix with the other colour, pull the deflection yoke backward.
 - Outside of the specified landing:
To front of the deflection yoke.
 - Inside of the specified landing:
To back of the deflection yoke.
 6. Set the raster rotation at "0" position (with the unit facing the east).
 7. Tighten the screws of the deflection coil.
Tightening torque: 11 kg \pm 2 kg.

色彩纯度调试

调试条件

1. 作此项调试之前, 请用大于500 μ A(型号14H-5C)或700 μ A(型号20H-5C和21H-5C)的电子束电流预热CRT装置30分钟。
2. 接收绿色单色信号, 并调节其电子束电流于500 μ A(型号14H-5C)或700 μ A(型号20H-5C和21H-5C)左右。
3. 通过消磁线圈对CRT作完全消磁处理。
4. 在作色彩纯度调试时, 必须先对静聚焦进行粗调。
5. 调节色彩纯度磁体, 使其磁场磁势为0。

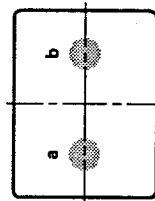

图A

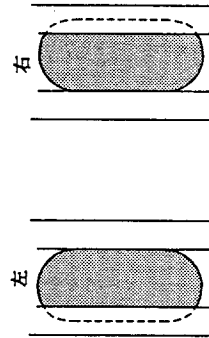

电子束射击点位置向外偏移

图B

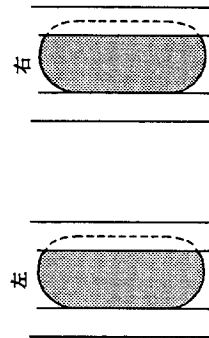

电子束射击点位置向右偏移

图C

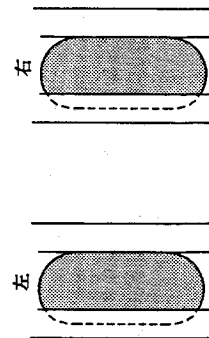

电子束射击点位置向左偏移

图D

调试方法

调试:
调试中, 必须保持CRT面向东方。

1. 用显示镜(放大镜)观察图A所示的两绿色色点("a"和"b"), 调节色彩纯度磁体, 使两色点位置符合规定要求为止。
 2. 如果两色点位置如图B所示各自发生左右偏差, 可向前按压偏转线圈将其校正。
 3. 如果两色点位置如图C或图D所示均发生向右或向左偏移现象, 可通过调节色彩纯度磁体的开启程度, 校正电子束射击点位置。
 4. 调节色彩纯度磁体, 校正绿色电子束在屏幕中心的射击点位置以及屏幕左右两边的射击点位置。然后, 检验在屏幕四角的射击点位置是否正确。最后, 按规范B级要求精确检查屏幕上任意点的着色电子束在屏幕的着色点掺杂有其它色彩, 可向后轻拉偏转线圈消除其它杂色。
- 着色点位置向外偏移:
前推偏转线圈加以调节。
 - 着色点位置向内偏移:
后拉偏转线圈加以调节。
6. 将光栅偏转角调节至0(CRT座南朝东)。
 7. 紧固扭矩: 11kg \pm 2kg

CONVERGENCE ADJUSTMENT

Adjusting Conditions

This adjustment should be performed after the purity magnet adjustment.

1. Receive "CROSSHATCH PATTERN (channel-E2)" signal.
2. Set the Brightness control and Contrast control at MAX position.

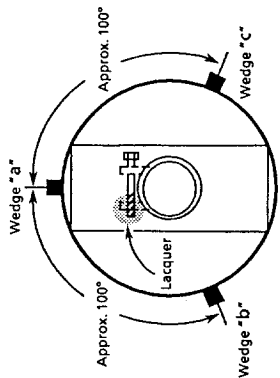

Adjusting Procedures

STATIC CONVERGENCE

1. Adjust the opening degree of the 4-pole magnet and rotate the magnet to converge red and blue lines.
2. Adjust the opening degree of the 6-pole magnet and rotate the magnet to converge red, blue and green lines.

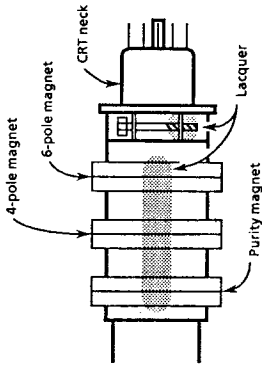

DYNAMIC CONVERGENCE

3. Dynamic convergence (convergence of the three colour fields) at the edges of CRT screen is accomplished in the following manner.

● **Convergence in Fig. a:** Insert wedge "a" between the deflection yoke and CRT, and tilt the deflection yoke upward until the mis-convergence shown in Fig. a is corrected.

● **Convergence in Fig. b:** Insert wedges "b" and "c" between the deflection yoke and CRT, and tilt the deflection yoke until the mis-convergence shown in Fig. b is corrected.

● **Convergence in Fig. c:** Insert wedge "c" deeply between the deflection yoke and CRT, and tilt the deflection yoke to right until the mis-convergence shown in Fig. c is corrected.

● **Convergence in Fig. d:** Insert wedge "b" deeply between the deflection yoke and CRT, and tilt the deflection yoke to left until the mis-convergence shown in Fig. d is corrected.

4. Stick the three wedges onto the CRT, and apply glass tapes thereon.

5. Apply lacquer to the deflection yoke screw, magnet unit (made of purity, 4-pole and 6-pole magnets) and magnet unit screw.

After the adjustment, receive either the Red or the Blue signal and check that there is no mixture with the other colour signal.

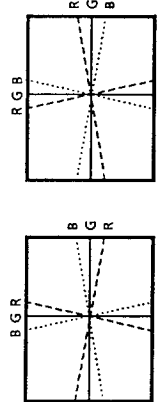

Figure b.

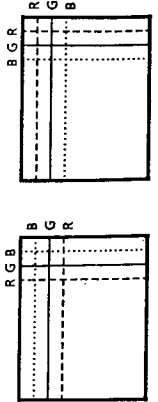

Figure d.

聚焦度的调试

调试条件

此项调试必须于色彩纯度调试之后进行。

1. 接收“棋盘格测试图(频道E2)信号。
2. 设亮度调节和对比度调节于最大位置。

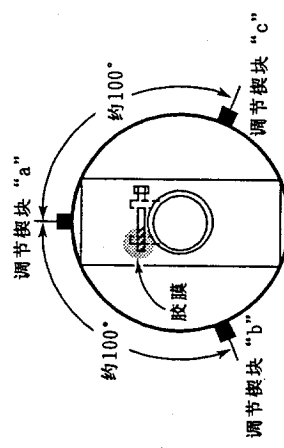

调试方法

静态聚焦度的调试

1. 调节4级聚焦磁铁的张开程度以及其转角, 以会聚红色线条和蓝色线条。
2. 调节6级聚焦磁铁的张开程度以及其转角, 以会聚红色线条, 蓝色线条和绿色线条。

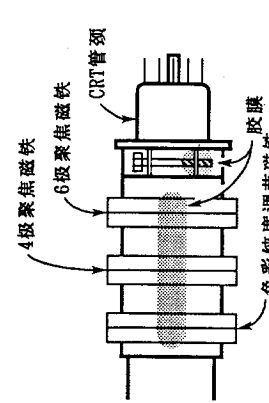

动态聚焦度的调试

3. CRT荧屏边缘的动聚焦度(三彩色色场的会聚)的调试按下述要求进行。

● 按图a. 要求的会聚调试: 插入调节楔块“a”于偏转线圈和CRT之间, 并向上倾斜调节偏转线圈, 以按图a. 所示要求矫正不良会聚。

● 按图b. 要求的会聚调试: 插入调节楔块“b”和“c”于偏转线圈和CRT之间, 并倾斜调节偏转线圈, 以按图b. 所示要求矫正不良会聚。

● 按图c. 要求的会聚调试: 深插调节楔块“c”于偏转线圈和CRT之间, 并向右倾斜调节偏转线圈, 以按图c. 所示要求矫正不良会聚。

● 按图d. 要求的会聚调试: 深插调节楔块“b”于偏转线圈和CRT之间, 并向左倾斜调节偏转线圈, 以按图d. 所示要求矫正不良会聚。

4. 完成以上调试后, 用透明胶膜粘固三只调节楔块于CRT。

5. 然后用胶膜封面偏转线圈调节螺丝, 调节磁铁装置(由纯度调节磁铁, 4级聚焦磁铁和6级聚焦磁铁构成)以及调节磁铁装置固定螺丝。

该项调试完成后, 让电视机接收红色或蓝色信号, 并检查接收的纯色信号是否掺杂有其他彩色信号。

故障检修表

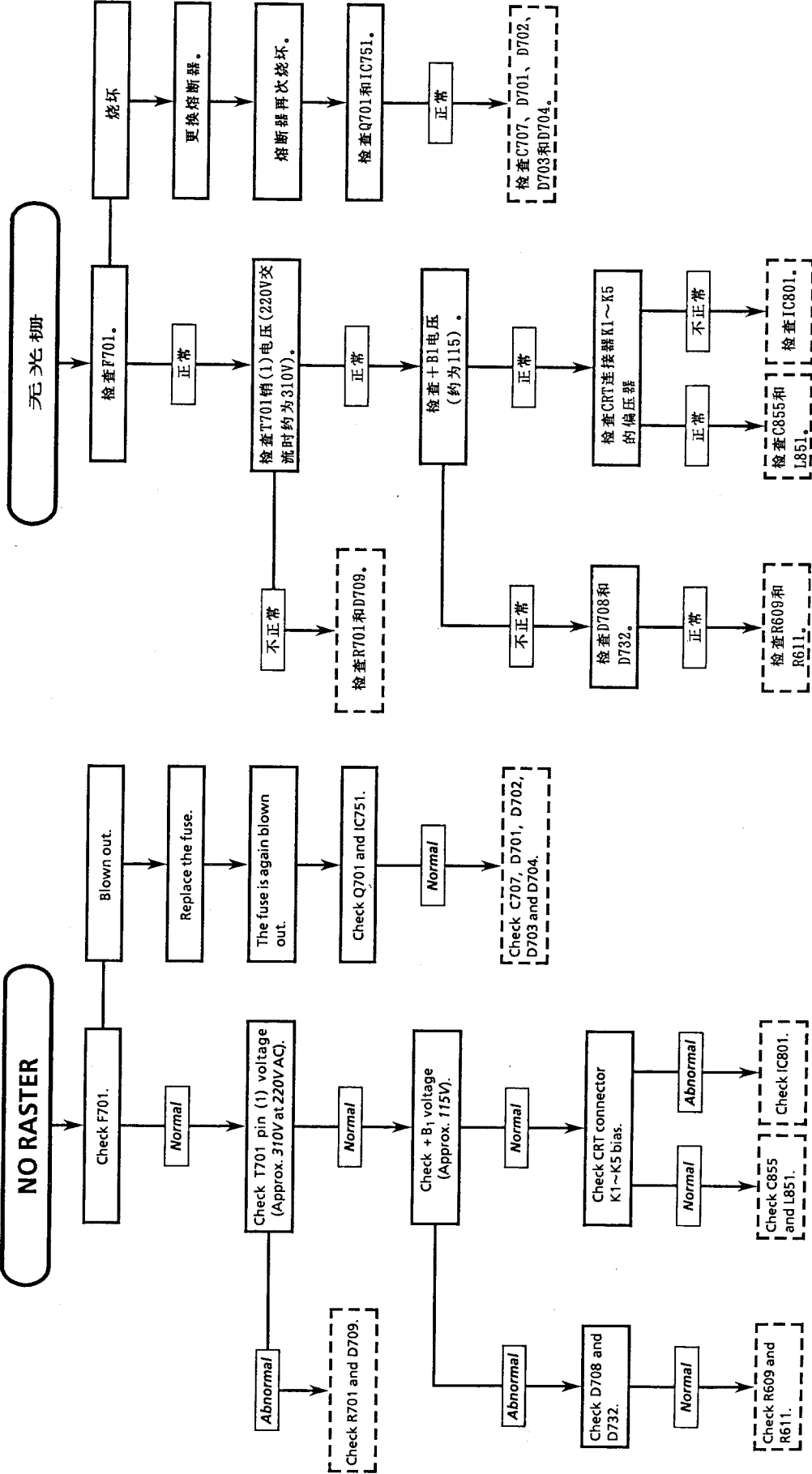

NO PICTURE, NO SOUND

CIRCUITS TO BE CHECKED:

- Tuner.
- PIF.
- Automatic Gain Control.
- +B₂ (8V), +B₃ (9V) Power Source.

Does the noise level increase at max. Contrast, Brightness and Sound controls?

Noise increases but no signal is received.

Check the tuner B₁, B_H, B_U and +B₃ biases. B₁ must be approx. 9V. B_H must be approx. 9V with the band switch at VHF position. B_U must be approx. 9V with the band switch at UHF position.

Picture noise decreases but sound level varies greatly.

Does the 8V + B₂ appear at pin (10) of IC801.

Normal
Abnormal

Check IC801.
Check D733, R731, R648 and IC602.

Normal
Abnormal

Check the tuner AGC.
Check IC801.

无图像、无声音

检查电路

- 调谐器电路
- PIF电路
- 自动增益控制电路
- +B₂ (8V)、+B₃ (9V) 电源电路

对比度、明亮度以及音量控制旋钮旋于最大时，噪声电平是否增大？

噪声增大，但无信号接收。

检查调谐器B₁、B_H和+B₃偏压。B₁应约为9V。B_H和B_U均应为9V。频率选择开关关于VHF位置时，BU应约为9V。频率选择开关关于UHF位置时，BU应约为9V。

显象噪声线减少，但声音电平变化剧烈。

IC801的销(10)处是否为8V+B₂？

正常
不正常

检查IC801。
检查D733、R731、R648和IC602。

正常
不正常

检查调谐器自动增益控制。
检查IC801。

NO SOUND

CIRCUITS TO BE CHECKED:

- SIF Amplifier Circuit.
- Sound Detector Circuit.
- Sound Switch and Att. Control.
- Audio Output Circuit.

Does approx. 10V appear at pin (1) of IC301?

No
Yes

Check Q304, D302 and F300.

Does approx. 9V appear at pin (7) of IC451?

Yes
No

Check R731 and IC602.

Does the noise level vary at max. sound control?

It does not vary.
Check IC801, Q302 and Q303.

无声音

检查电路

- SIF放大器电路
- 声音检波电路
- 音量调整和衰减控制电路
- 音频输出电路

IC301的销(1)处是否约为10V？

否
是

检查Q304、D302以及F300。

IC451的销(9)处是否约为9V？

否
是

检查R731以及IC602。

当音量控制于最大位置时，噪声电平有否变化？

无变化。
检查IC801、Q302以及Q303。

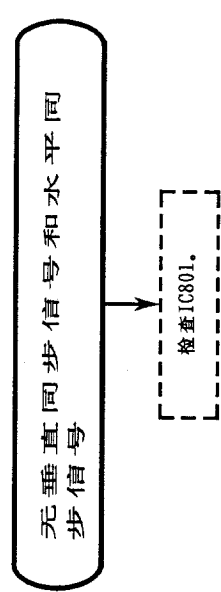
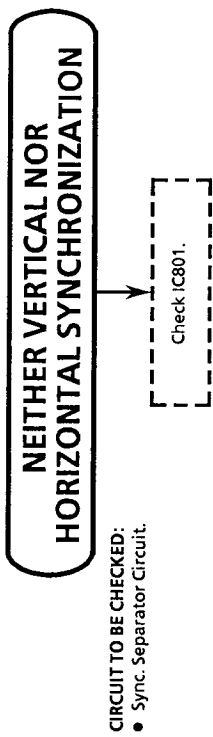

检查电路：
● 同步分离电路

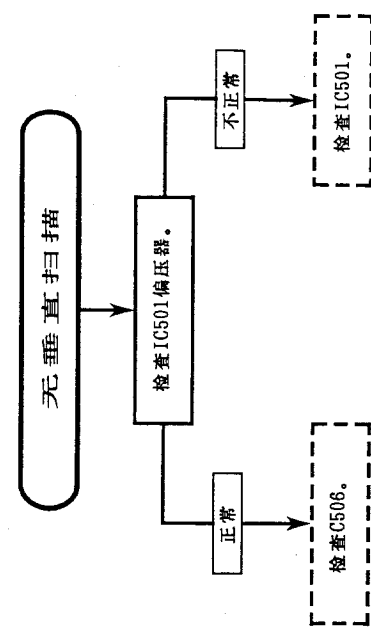
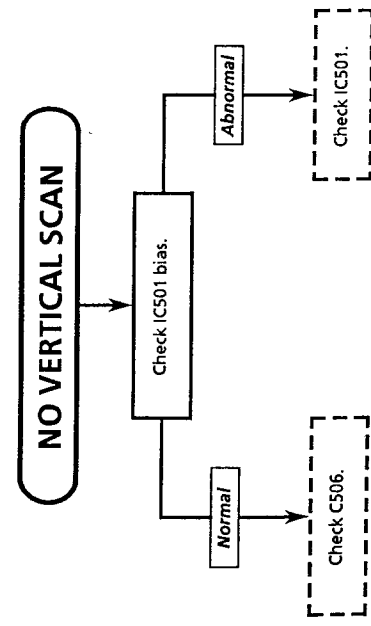
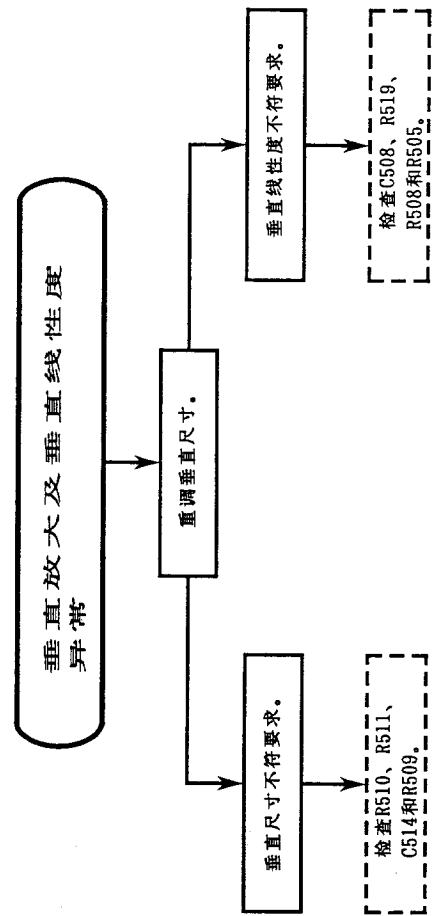
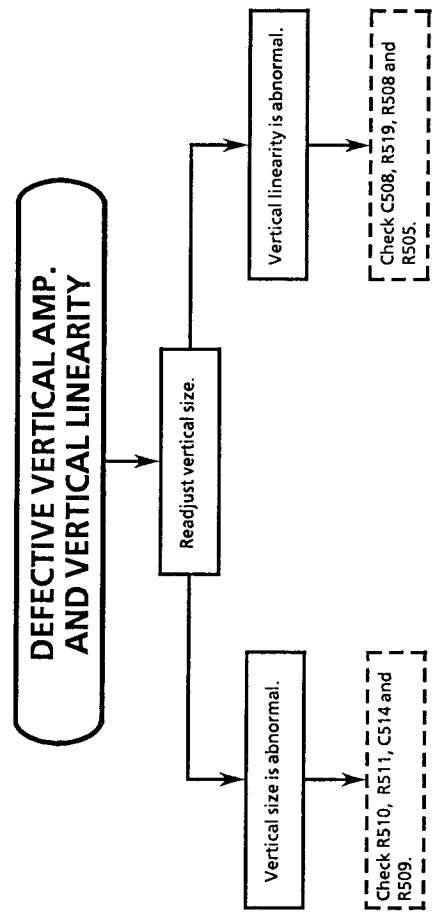

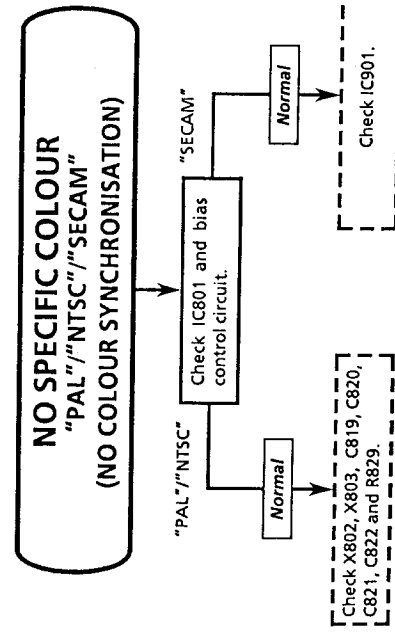
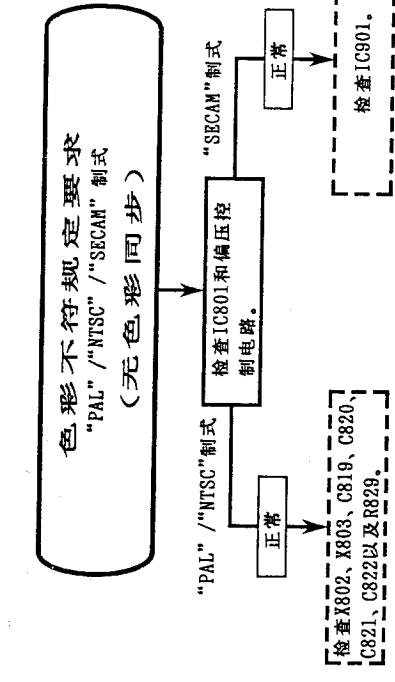
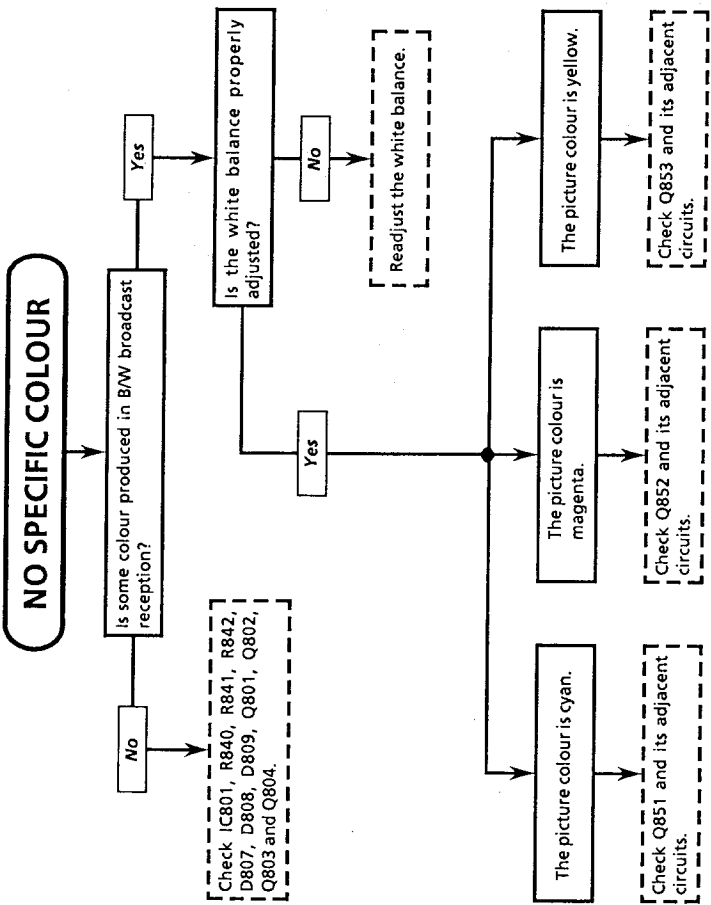
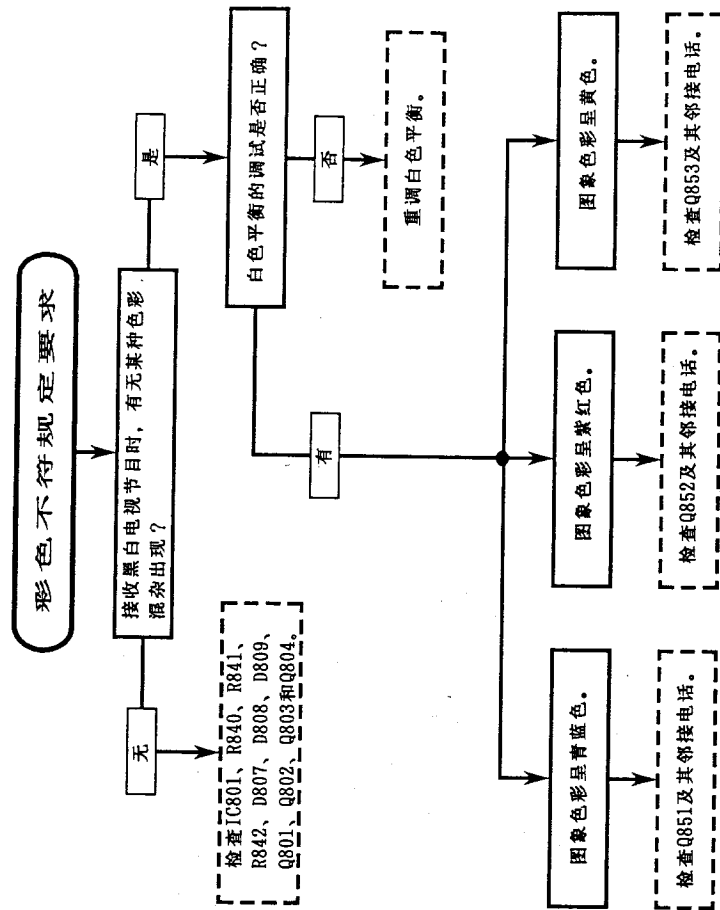

MODEL 14H-SC CHASSIS LAYOUT

型号14H-SC 机芯底盘电路布置

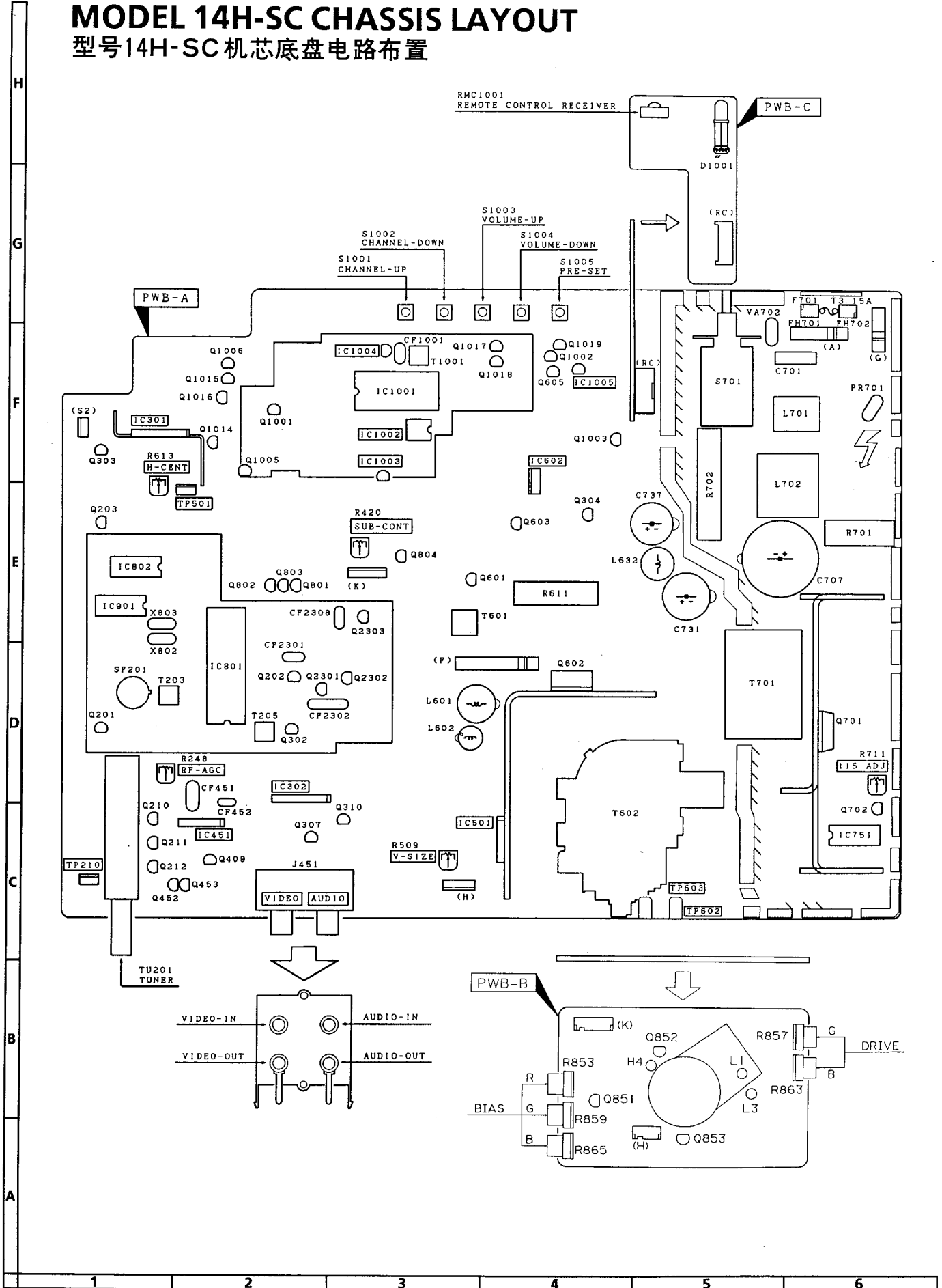

MODELS 20H-SC and 21H-SC CHASSIS LAYOUT

型号20H-SC与21H-SC机芯底盘电路布置

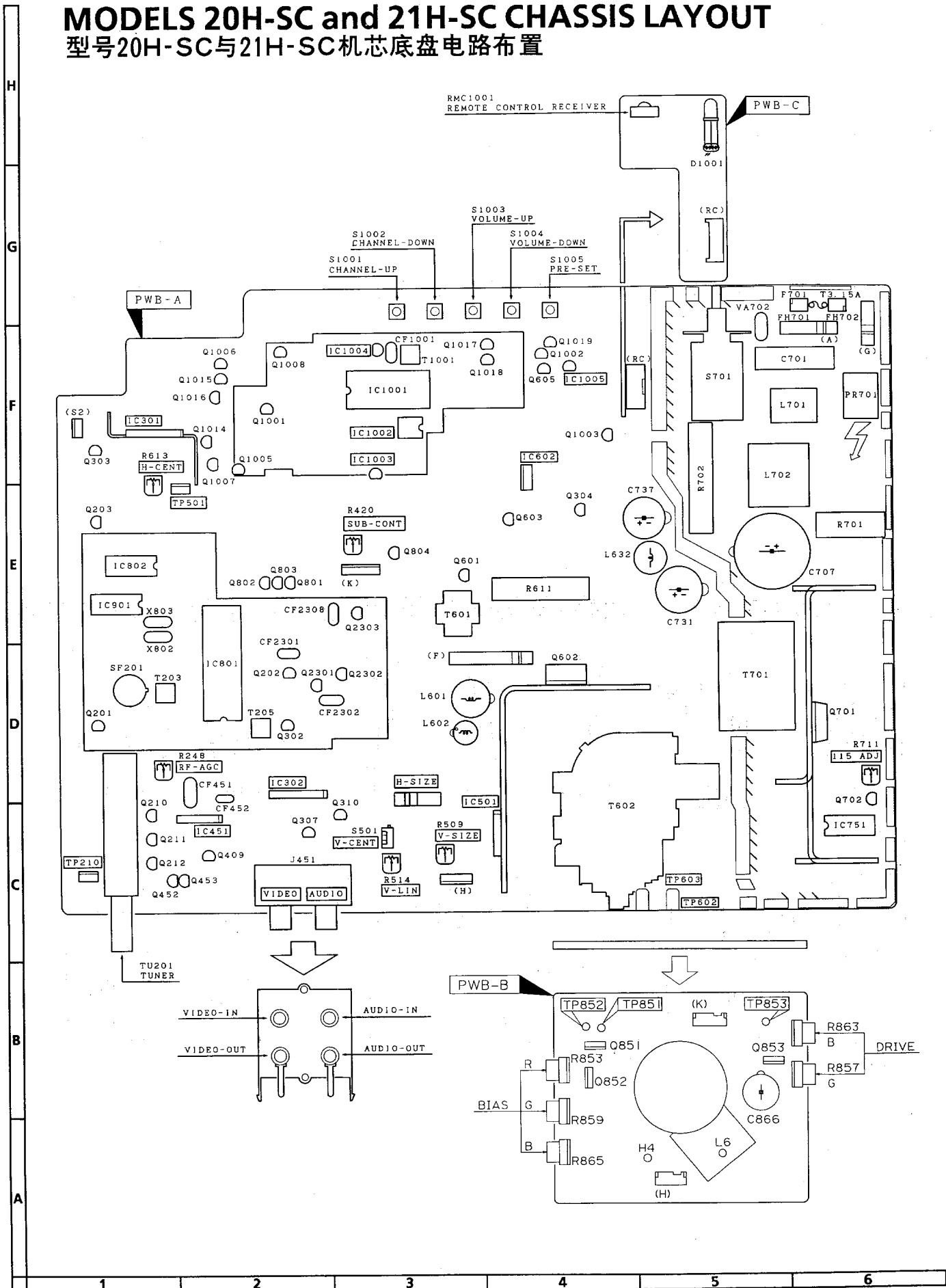

SOLID STATE DEVICE BASE DIAGRAM

固体器件基座图

TOP VIEW 俯视图

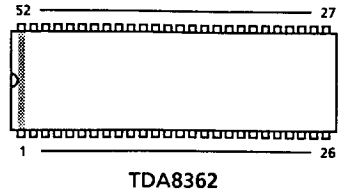
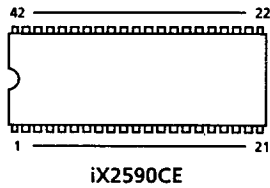
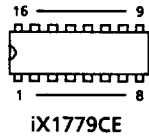
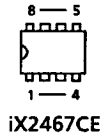

SIDE VIEW 侧视图

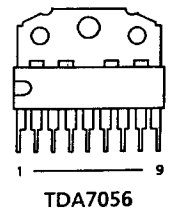
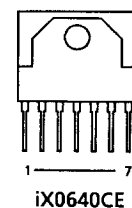
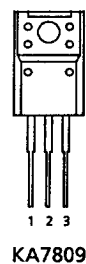
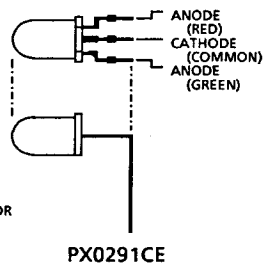
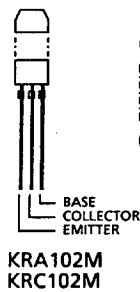
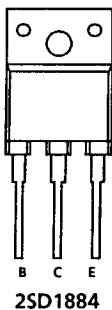
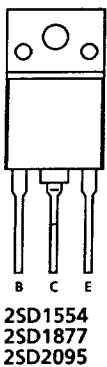
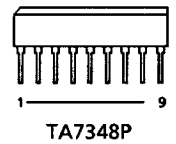
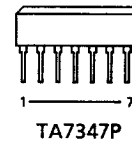
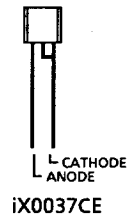
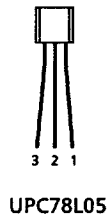
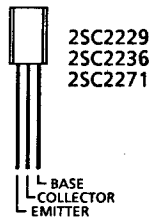
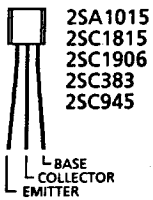

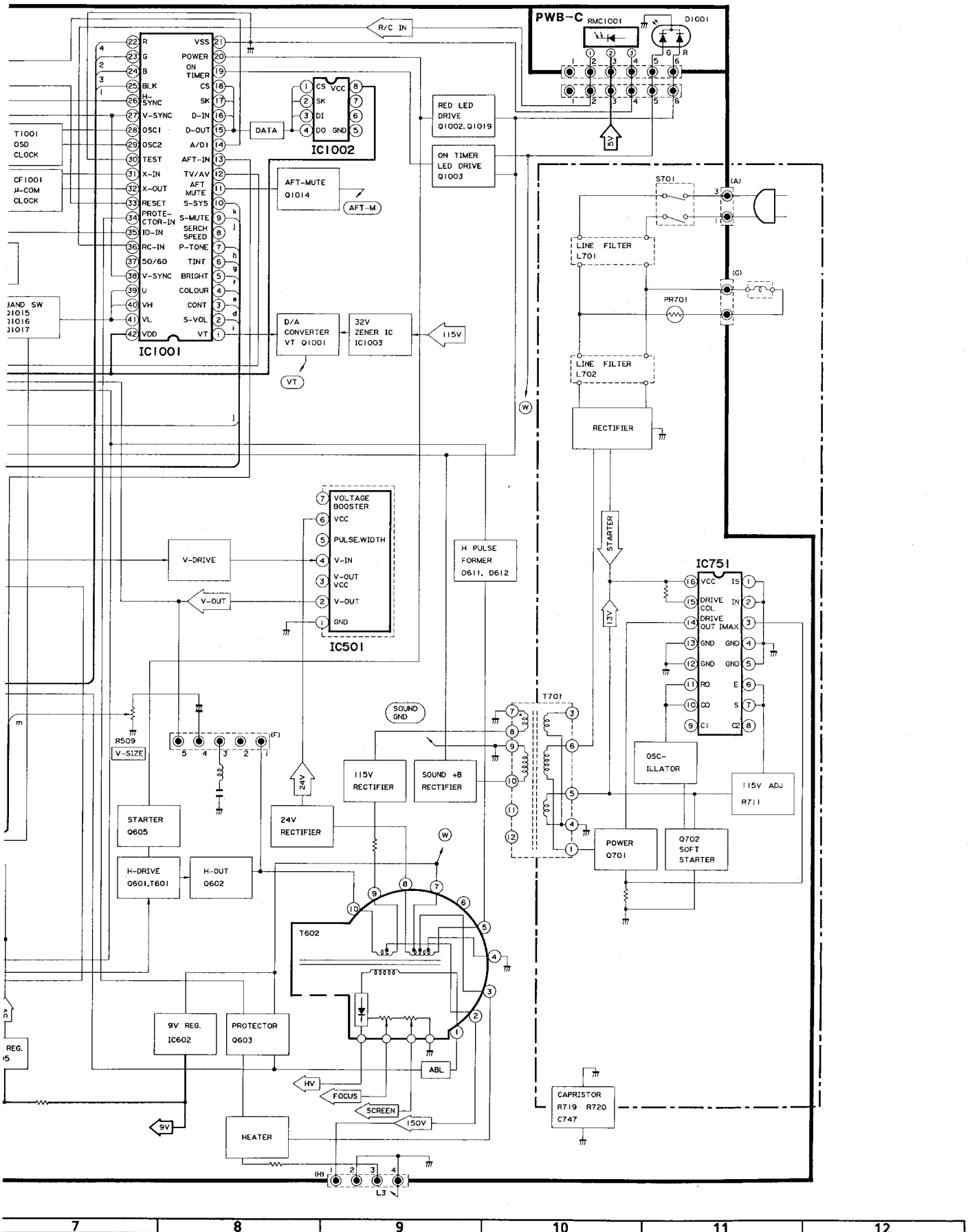

MODEL 14H-SC BLOCK DIAGRAM

型号14H-SC电路方框图

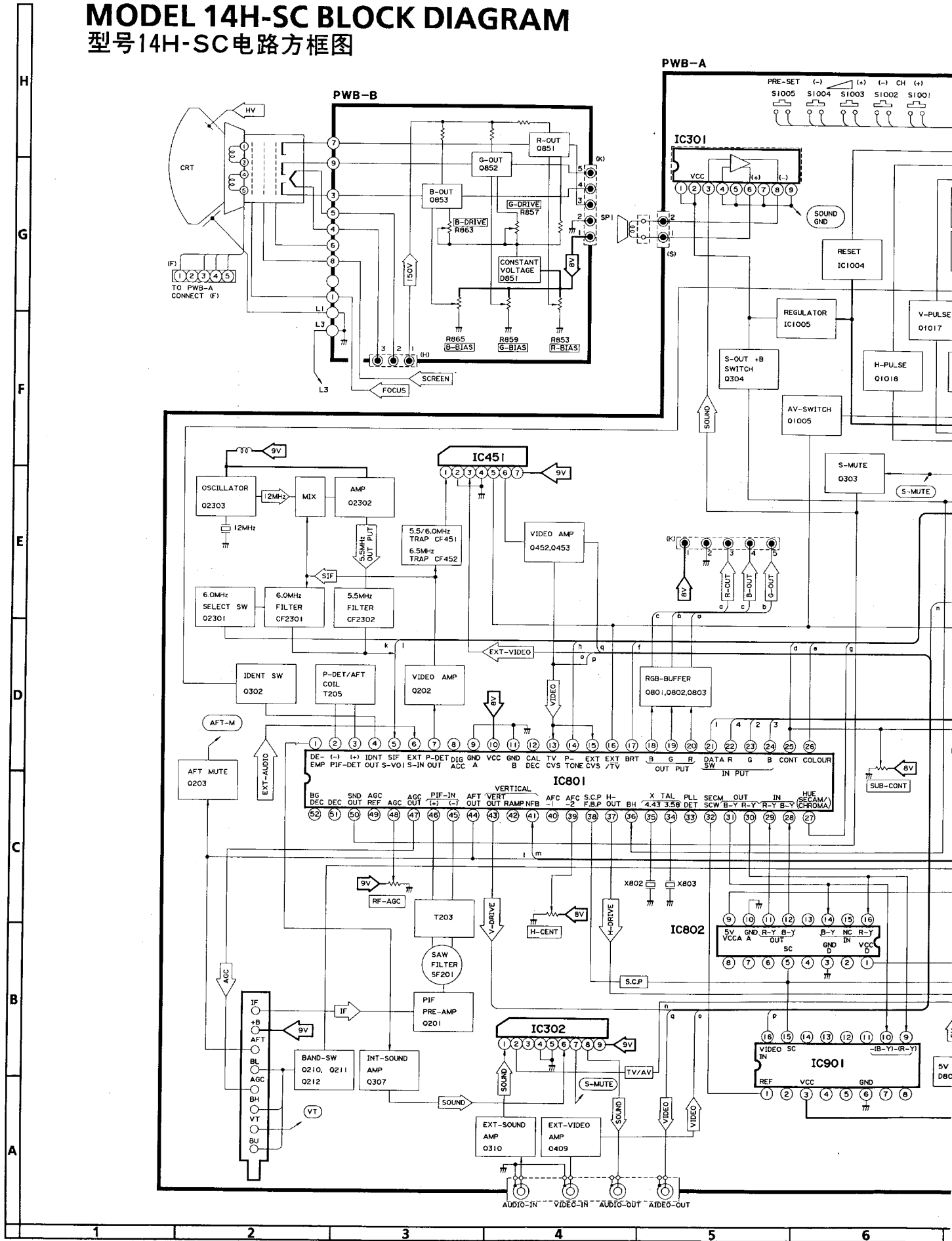

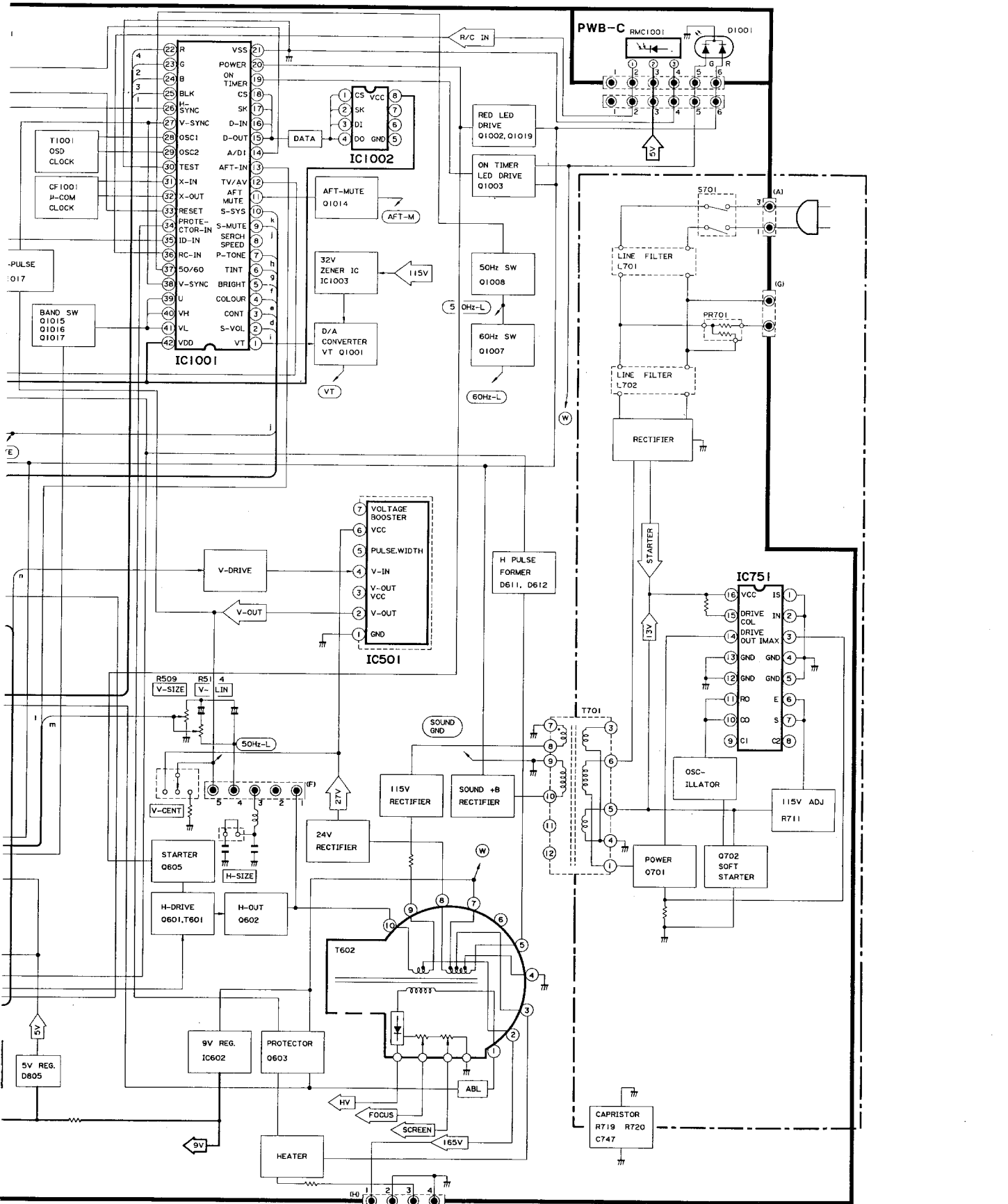

7

8

9

10

11

12

PRINTED WIRING BOARD ASSEMBLIES

(All the PWBs here are shown as viewed from their wiring sides.)

印刷电路板的组装件

(这里所有印刷电路都是从线路贴置侧显示出来的。)

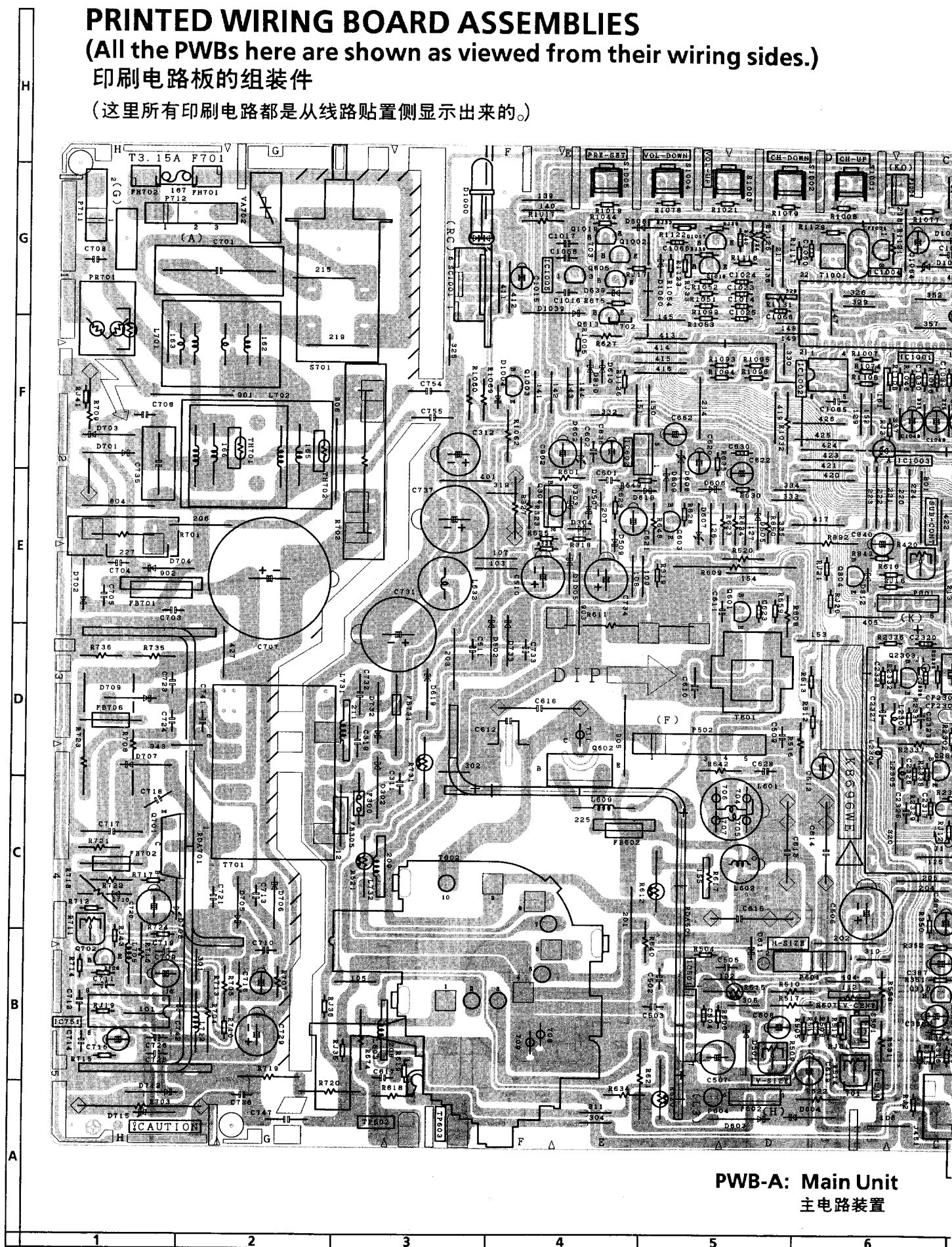

PWB-A: Main Unit
主电路装置

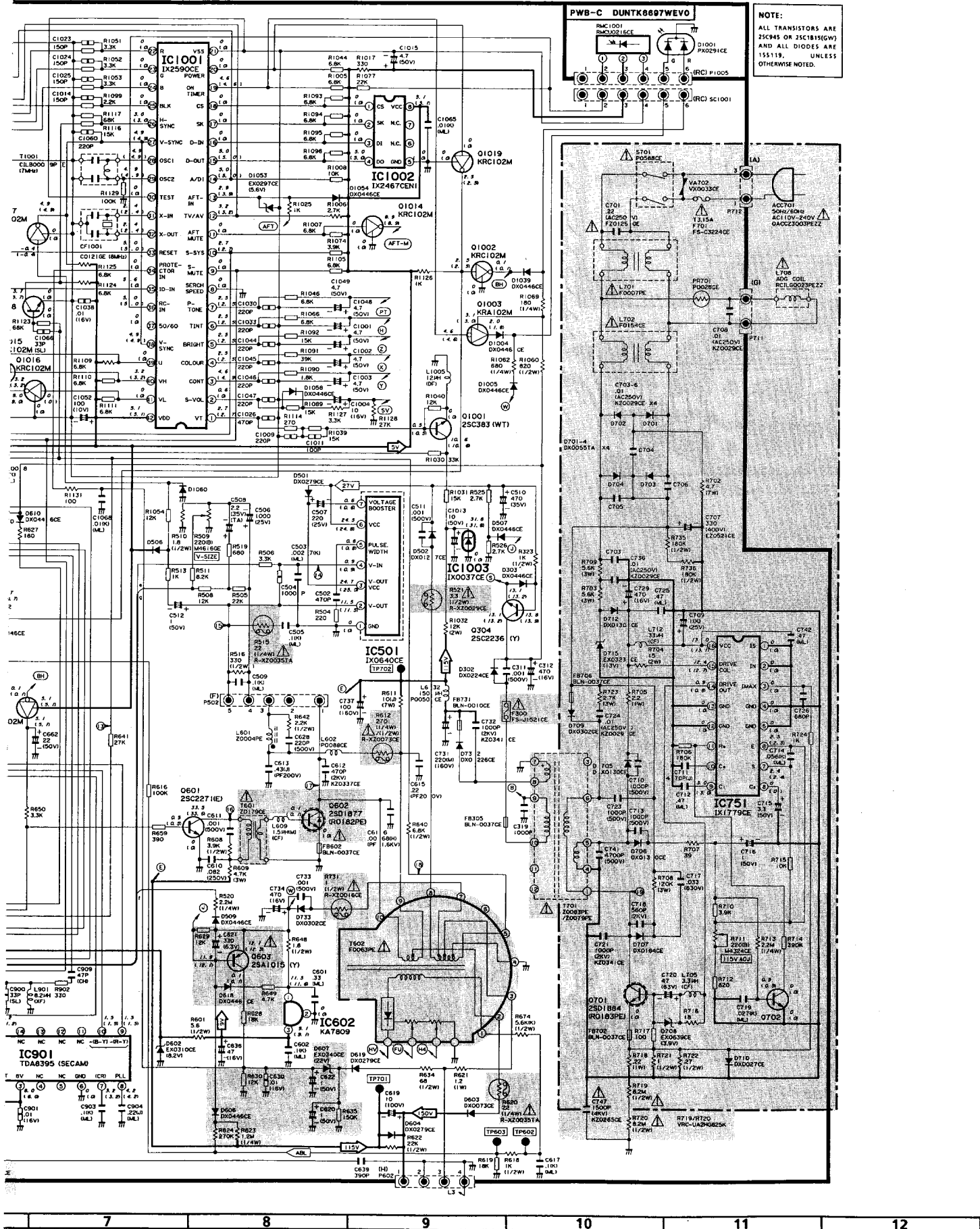

PWB-C DUNK8687WEVO

NOTE:
ALL TRANSISTORS ARE
2SC945 OR 2SC1815(GW)
AND ALL DIODES ARE
1S5119, UNLESS
OTHERWISE NOTED.

MODEL 14H-SC SCHEMATIC DIAGRAM

型号14H-SC电路原理图

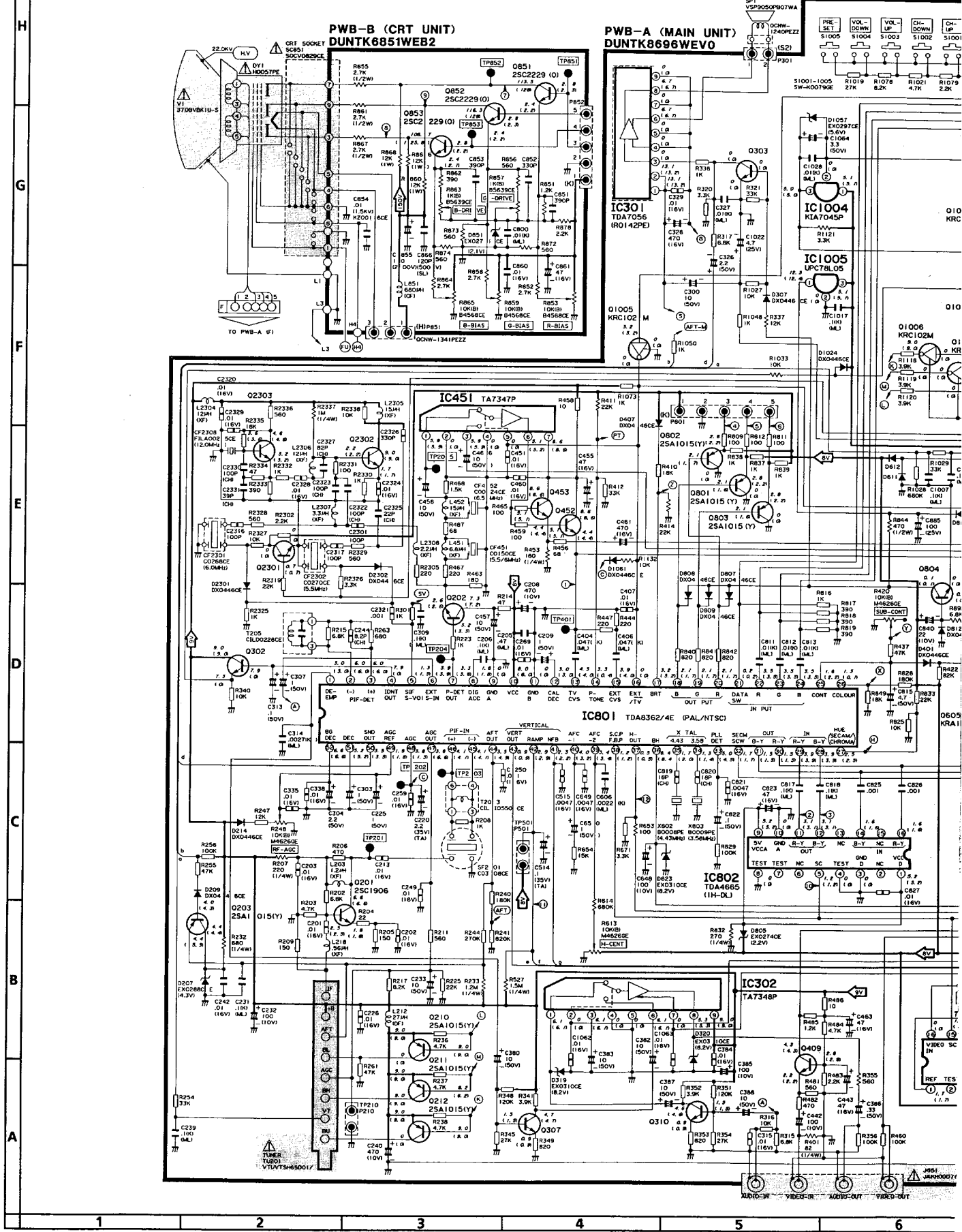

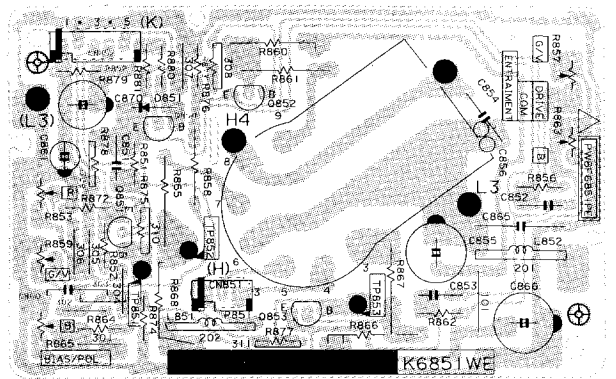
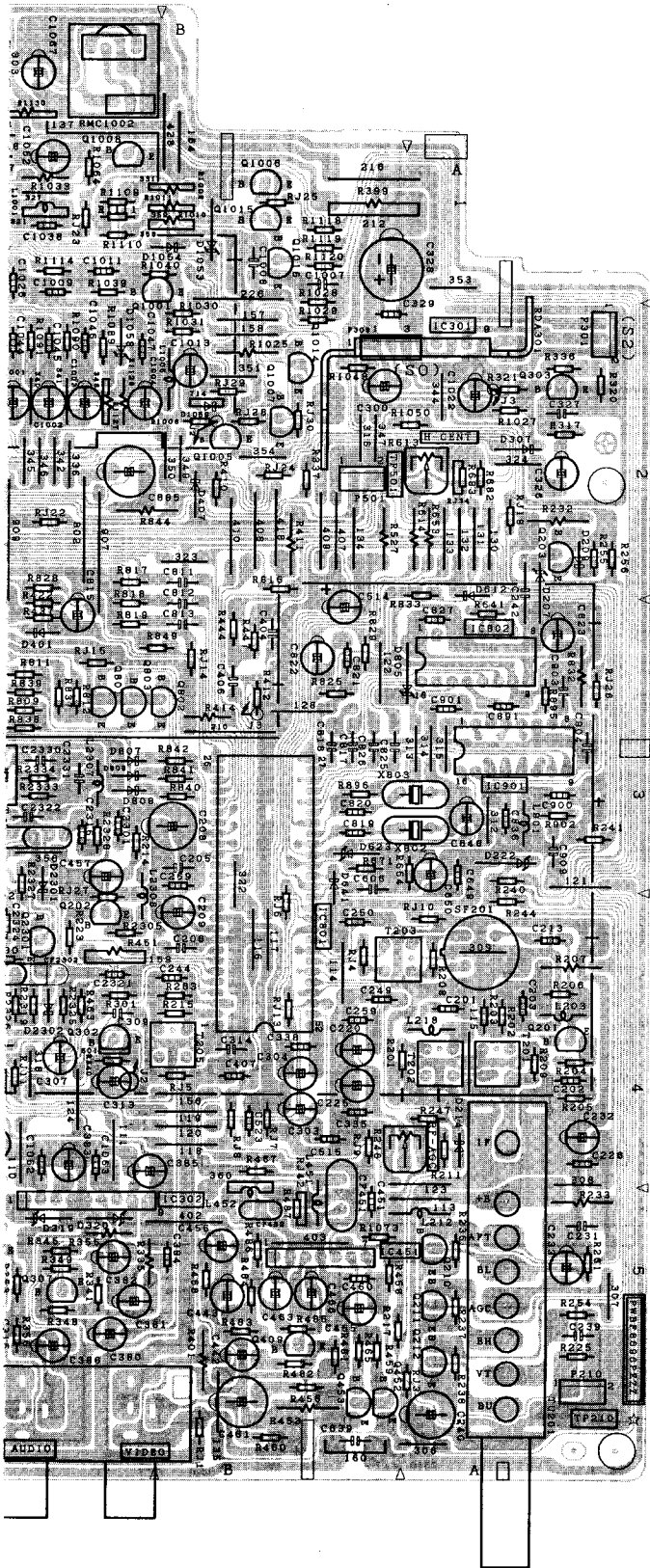

PWB-B: CRT Socket Unit
CRT管座装置印刷电路板
(14H-SC)

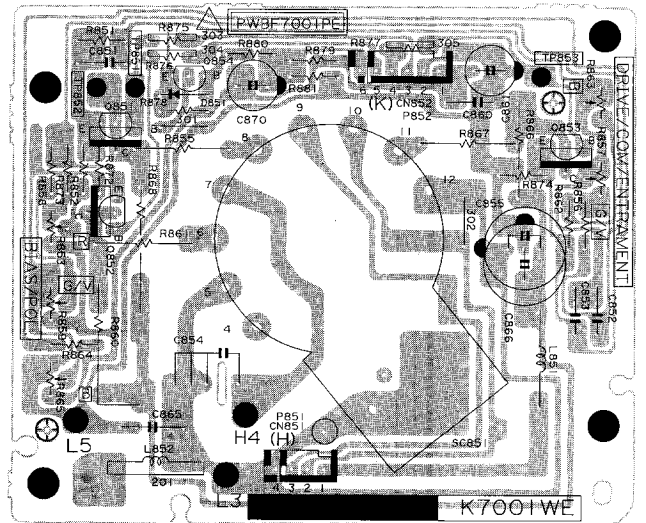

PWB-B: CRT Socket Unit
CRT管座装置印刷电路板
(20H-SC, 21H-SC)

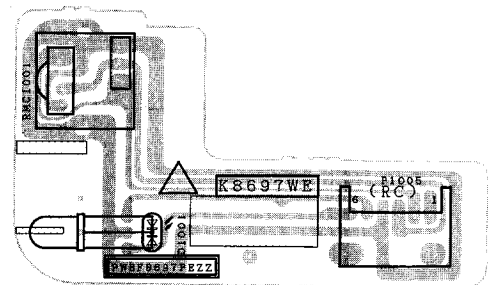

PWB-C: LED, R/C Receiver Unit
LED装置与遥控信号接收器印刷电路板

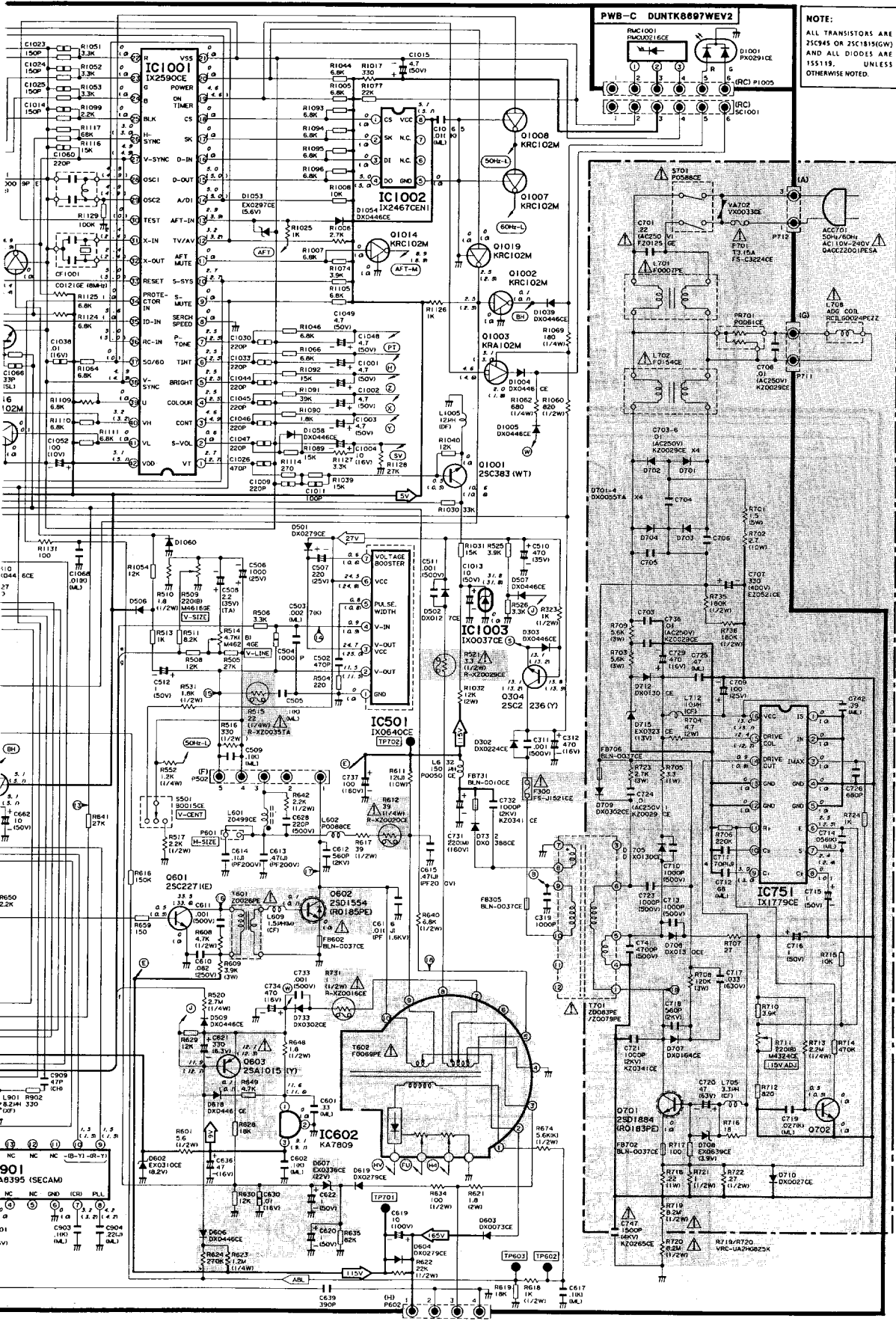

NOTE:
ALL TRANSISTORS ARE
2SC48 OR 2SC1815(W)
AND ALL DIODES ARE
15S119. UNLESS
OTHERWISE NOTED.

:901
A8395 (SECAM)
NC NC NC (-B-Y) (-R-Y)
NC NC NC NC NC NC
C903 (10K)
C904 (220K)
C905 (6V)

WAVEFORMS

波形图

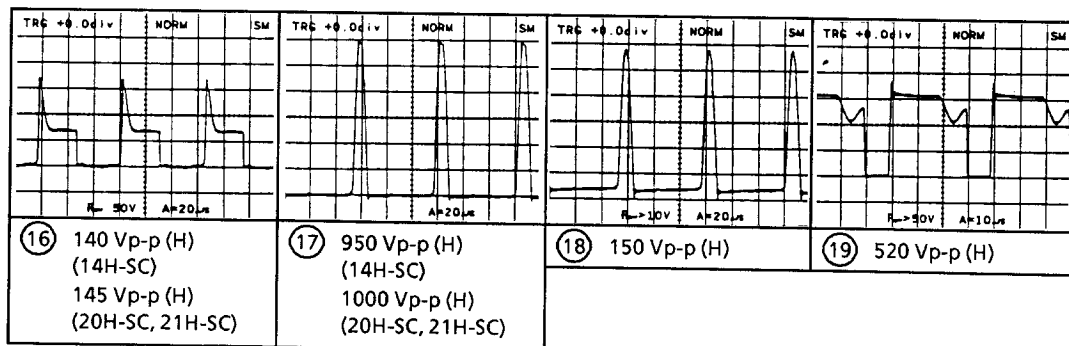
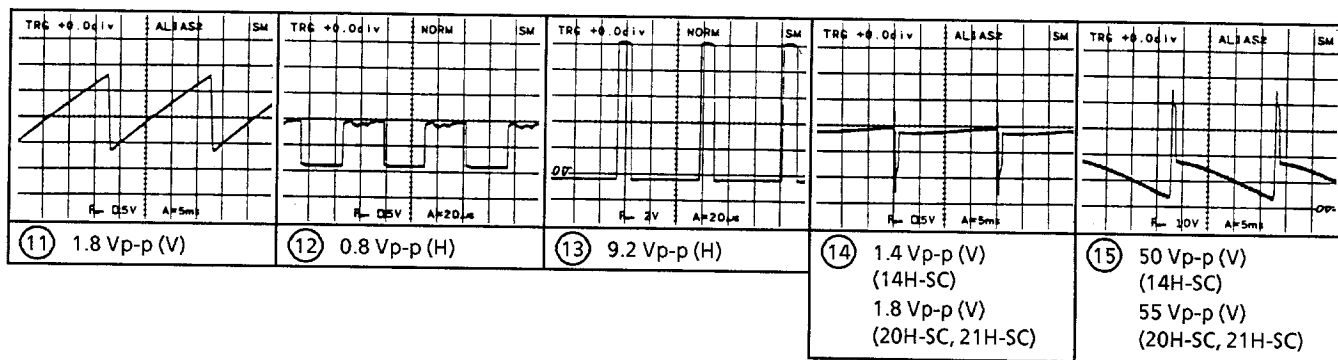
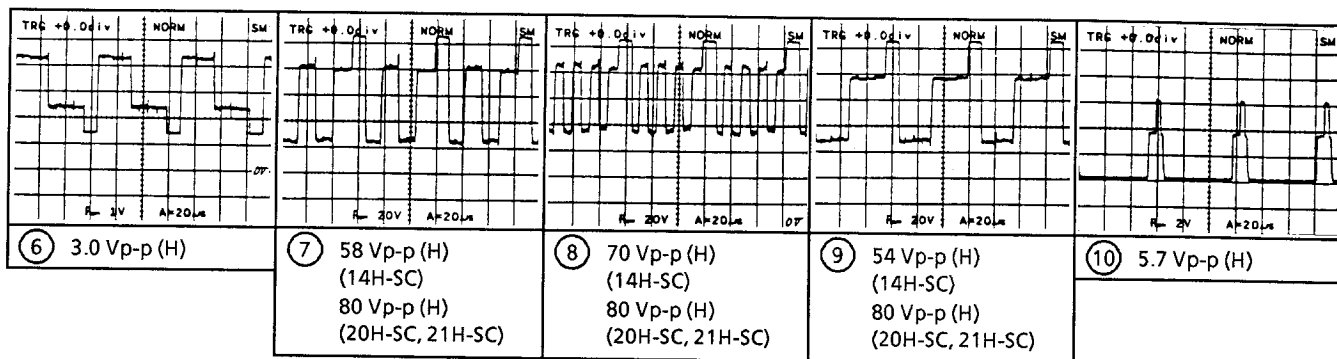
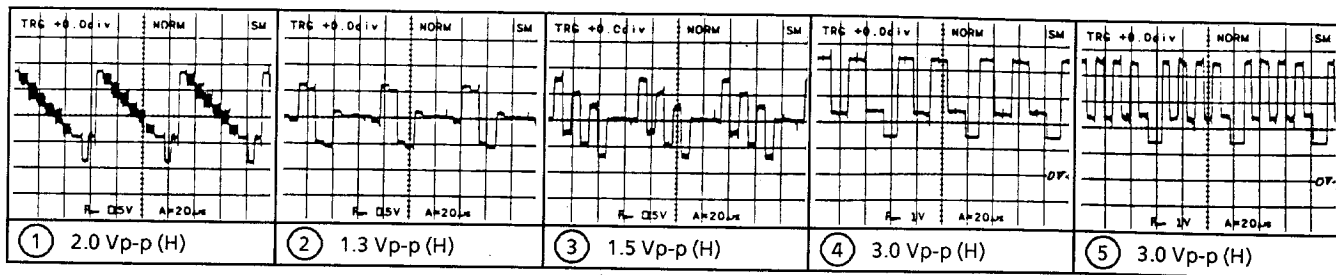

Tuner 调谐器

NOTE: The parts here shown are supplied as an assembly but not independently.

注意：在更换零件订货时，请以一套为最小单位，切勿以单件订货。

VTUVTSH6SD01/

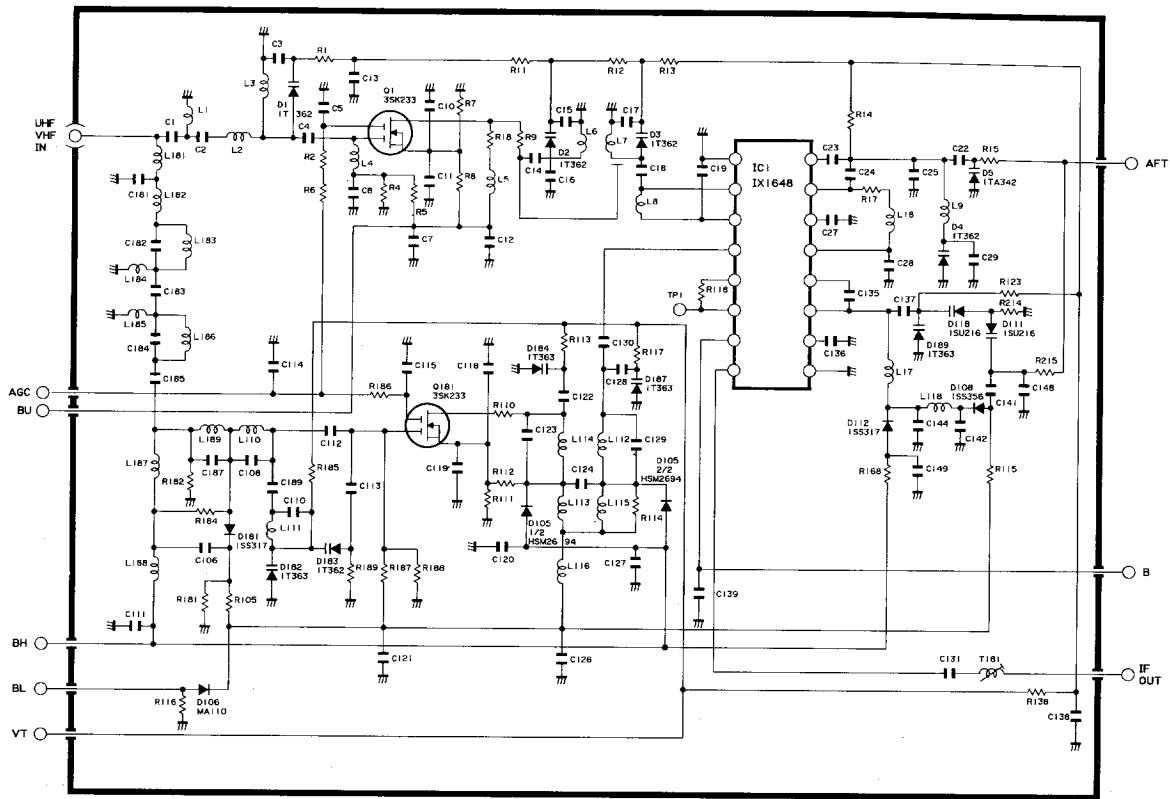

Infrared Remote Control Unit 红外线遥控器

NOTE: The parts here shown are supplied as an assembly but not independently.

注意：在更换零件订货时，请以一套为最小单位，切勿以单件订货。

RRMCG1133PESA

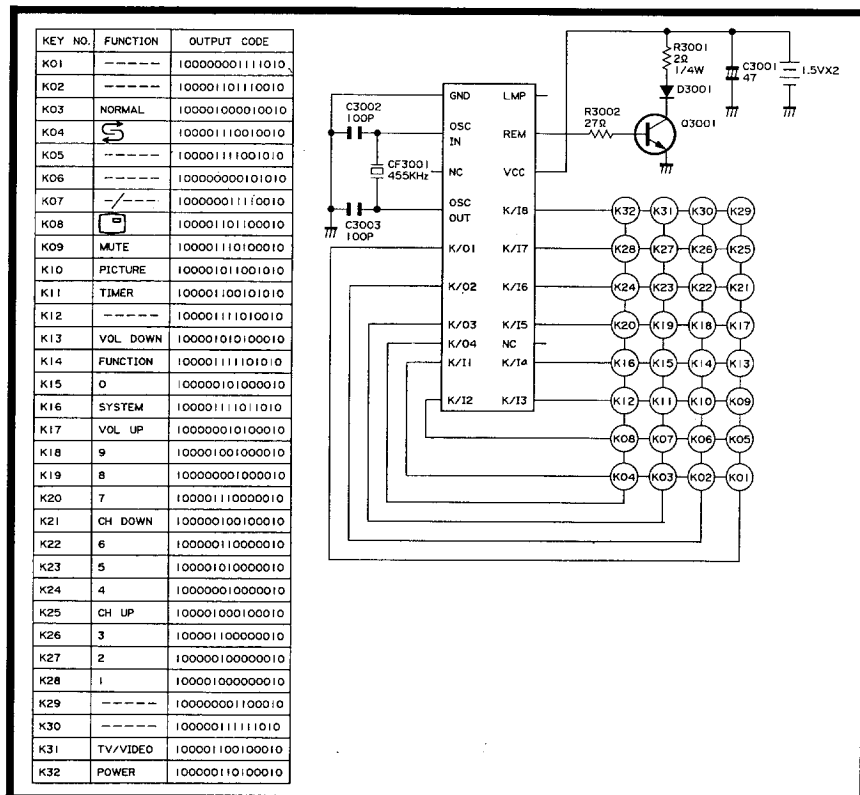

DESCRIPTION OF SCHEMATIC DIAGRAM

SAFETY NOTE:

1. DISCONNECT THE AC PLUG FROM THE AC OUTLET BEFORE REPLACING PARTS.
2. SEMICONDUCTOR HEAT SINKS SHOULD BE REGARDED AS POTENTIAL SHOCK HAZARDS WHEN THE CHASSIS IS OPERATING.

IMPORTANT SAFETY NOTICE:

PARTS MARKED WITH "△" () ARE IMPORTANT FOR MAINTAINING THE SAFETY OF THE SET. BE SURE TO REPLACE THESE PARTS WITH SPECIFIED ONES FOR MAINTAINING THE SAFETY AND PERFORMANCE OF THE SET.

SERVICE PRECAUTION:

THE AREA ENCLOSED BY THIS LINE () IS DIRECTLY CONNECTED WITH AC MAINS VOLTAGE. WHEN SERVICING THE AREA, CONNECT AN ISOLATING TRANSFORMER BETWEEN TV RECEIVER AND AC LINE TO ELIMINATE HAZARD OF ELECTRIC SHOCK.

NOTE:

1. The unit of resistance "ohm" is omitted (K = 1000 ohms, M = Megaohm).
2. All resistors are 1/8 watt, unless otherwise noted.
3. All capacitors are μF , unless otherwise noted (P = $\mu\mu F$).

VOLTAGE MEASUREMENT CONDITIONS:

1. Voltages in parenthesis measured with no Signal.
2. Voltages without parenthesis measured with 3mV B & W or Colour-Signal.
3. All the voltages in each point are measured with VTVM.

WAVEFORM MEASUREMENT CONDITIONS:

1. Colour bar generator signal of 1.5 V peak to peak applied at Base of Video Buffer Amp. Q202.
2. Approximately 4.0 V AGC bias.

电路原理图的说明

安全使用注意事项：

1. 在进行部件更换之前，务请拔出电源插头。
2. 本装置工作时，机芯底盘的半导体散热片有触电之虑，务请注意。

安全使用注意要点：

标有"△"()的部件对于电视机安全的维护有至关重要的意义。为了维护本机的安全和使本机正常工作，必须使用指定品来更换这些部件。

维修注意：

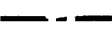
被()线围起的地方直接和交流电源电压相连接。当对该处进行维修时，为了排除遭受电击的危险性，要在电视接收机和交流电源之间连接隔离变压器。

电路单位说明：

1. 电阻欧姆(Ω)单位予以略记(K = 千欧姆, M = 兆欧姆)。
2. 除特别说明者外，图中电阻功率均为1/8瓦特。
3. 除特别说明者(P = 微微法拉)外，图中电容单位均为 μF (微法拉)。

电压测定条件：

1. 括号中的电压值为无信号状态下所测。
2. 括号外的电压值为3mV黑白或彩色信号状态下所测。
3. 所有测点的电压值均为电子管电压计VTVM所测。

波形测定条件：

1. 施加1.5Vp-p的彩条发生器信号于视频缓冲放大器Q202的基极。
2. 约4.0V自动增益控制偏压。

PARTS LIST

PARTS REPLACEMENT

Replacement parts which have these special safety characteristics identified in this manual: electrical components having such features are identified by "△" in the Replacement Parts Lists.

The use of a substitute replacement part which does not have the same safety characteristics as the factory recommended replacement parts shown in this service manual may create shock, fire or other hazards.

"HOW TO ORDER REPLACEMENT PARTS"

To have your order filled promptly and correctly, please furnish the following informations.

- | | |
|-----------------|----------------|
| 1. MODEL NUMBER | 2. REF. NO. |
| 3. PART NO. | 4. DESCRIPTION |
| 5. CODE | 6. QUANTITY |

MARK ★: SPARE PARTS-DELIVERY SECTION.

Ref. No.	Part No.	★	Description	Code
----------	----------	---	-------------	------

PICTURE TUBE

MODEL 14H-SC

△ V1	VB370BVBK1U-S	R	CRT, 37 cm (14 inch)	BX
△ DY1	RCiLH0057PEZZ	R	Deflection Yoke	BB
△ L708	RCiLG0023PEZZ	R	Degaussing (ADG) Coil	AN
	PMAGF3006CEZZ	J	Purity Magnet	AK
	PSPAG0004PEZZ	R	Wedge, Rubber, x3	AB
	LHLDW0003PEKZ	R	ADG Coil Holder, x4	AB
	MSPRT0001PEFJ	R	CRT Spring	AC

MODEL 20H-SC

△ V1	VB48JSK61X/2E	R	CRT, 48 cm (20 inch)	CE
△ DY1	RCiLH0022PEZZ	R	Deflection Yoke	BH
△ L708	RCiLG0024PEZZ	R	Degaussing (ADG) Coil	AW
	PMAGF3003CEZZ	J	Purity Magnet	AK
	PSPAG0003PEZZ	R	Wedge, Rubber, x3	AD
	LHLD0001PEZZ	R	ADG Coil Holder, x4	AC
	MSPRT0001PEFJ	R	CRT Spring	AC

MODEL 21H-SC

△ V1	VB51JFC61X/*P	R	CRT, 51 cm (21 inch)	CK
△ DY1	RCiLH1576CEZZ	J	Deflection Yoke	BD
△ L708	RCiLG0025PEZZ	R	Degaussing (ADG) Coil	AW
	PMAGF3003CEZZ	J	Purity Magnet	AK
	PSPAG0003PEZZ	R	Wedge, Rubber, x3	AD
	LHLDW0003PEKZ	R	ADG Coil Holder, x4	AB
	MSPRT0001PEFJ	R	CRT Spring	AC

— End of PICTURE TUBE —

更换零件表

更换零件

本维修说明书对具有特别安全要求的零件均用标记加以识别。在此更换零件表中，具有特别安全要求的电路元件均用△标记以便注意识别。更换零件时，为了用户的安全以及电视机原有的工作性能，务请使用夏普规定零件。否则，可能有导致触电、火灾或其他不测事故发生的可能。

更换零件的订货方法

为了能迅速而确实地接受订货，以及正确无误地按时交货，在订货时请将下列各项明确告知。

- | | |
|---------|---------|
| 1. 型号 | 2. 参考编号 |
| 3. 零件编号 | 4. 零件名称 |
| 5. 代号 | 6. 数量 |

附★记号为备用部件的交货部门

Ref. No.	Part No.	★	Description	Code
----------	----------	---	-------------	------

PRINTED WIRING BOARD ASSEMBLIES (NOT REPLACEMENT ITEM)

MODEL 14H-SC

PWB-A	DUNTK8696WEV0	-	Main Unit	—
PWB-B	DUNTK6851WEB2	-	CRT Socket Unit	—
PWB-C	DUNTK8697WEV0	-	LED, R/C Receiver Unit	—

MODEL 20H-SC

PWB-A	DUNTK8696WEV2	-	Main Unit	—
PWB-B	DUNTK7001WEF3	-	CRT Socket Unit	—
PWB-C	DUNTK8697WEV2	-	LED, R/C Receiver Unit	—

MODEL 21H-SC

PWB-A	DUNTK8696WEV1	-	Main Unit	—
PWB-B	DUNTK7001WEE8	-	CRT Socket Unit	—
PWB-C	DUNTK8697WEV1	-	LED, R/C Receiver Unit	—

— End of P. W. B. ASSEMBLIES —

Ref. No.	Part No.	*	Description	Code	Ref. No.	Part No.	*	Description	Code
PWB-A DUNTK8696WEV0/V2/V1 MAIN UNIT					TRANSISTORS (Continued)				
TUNER									
<i>NOTE: THE PARTS HERE SHOWN ARE SUPPLIED AS AN ASSEMBLY BUT NOT INDEPENDENTLY.</i>									
△ TU201	VTUVTSH6SD01/	J	Tuner, VHF/UHF	BD	Q1001	VS2SC383-WT-1	J	2SC383(WT)	AE
INTEGRATED CIRCUITS									
IC301	VHITDA7056/-1	J	Sound Output	AP	Q1002	VSKRC102M//-1	J	KRC102M	AA
IC302	VHITA7348P/-1	J		AK	Q1003	VSKRA102M//-1	J	KRA102M	AA
IC451	VHITA7347P/-1	J		AG	Q1005	VSKRC102M//-1	J	KRC102M	AA
IC501	RH-iX0640CEZZ	J	LA7830, Vertical Output	AK	Q1006	VSKRC102M//-1	J	KRC102M	AA
IC602	VHKA7809Pi-1	J	9V Regulator	AE	Q1007	VSKRC102M//-1	J	KRC102M (20H-SC, 21H-SC)	AA
△ IC751	RH-iX1779CEZZ	J	TEA2261, Power Reg.	AR	Q1008	VSKRC102M//-1	J	KRC102M (20H-SC, 21H-SC)	AA
IC801	VHITDA8362/4E	J	Video/Chroma/Jungle IC, BA PAL/NTSC	BA	Q1014	VSKRC102M//-1	J	KRC102M	AA
IC802	VHITDA4665/-1	J	1H-DL	AR	Q1015	VSKRC102M//-1	J	KRC102M	AA
IC901	VHITDA8395/-1	J	SECAM	AY	Q1016	VSKRC102M//-1	J	KRC102M	AA
IC1001	RH-iX2590CEZZ	J	TMP87CH36N3112, Micriprocessor	AY	Q1017	VSKRC102M//-1	J	KRC102M	AA
IC1002	RH-iX2467CEN1	J	ST93C46CB1, Memory	AK	Q1018	VS2SC1815GW-1	J	2SC1815(GW)	AB
IC1003	RH-iX0037CEZZ	J	Zener IC, UPC574J	AF	Q1019	VSKRC102M//-1	J	KRC102M	AA
IC1004	VHiKiA7045P-1	J	Reset IC	AD	Q2301	VS2SC945AP/-1	J	2SC945	AB
IC1005	VHiUPC78L05-4	J	5V Regulator	AD	Q2302	VS2SC1815GW-1	J	2SC1815(GW)	AB
TRANSISTORS					DIODES				
Q201	VS2SC1906//1E	J	2SC1906	AC	D207	RH-EX0288CEZZ	J	Zener Diode, 4.3V	AA
Q202	VS2SC945AP/-1	J	2SC945	AB	D209	RH-DX0446CEZZ	J		AB
Q203	VS2SA1015Y/1E	J	2SA1015(Y)	AC	D214	RH-DX0446CEZZ	J		AB
Q210	VS2SA1015Y/1E	J	2SA1015(Y)	AC	D302	RH-DX0224CEZZ	J		AB
Q211	VS2SA1015Y/1E	J	2SA1015(Y)	AC	D303	RH-DX0446CEZZ	J		AB
Q212	VS2SA1015Y/1E	J	2SA1015(Y)	AC	D307	RH-DX0446CEZZ	J		AB
Q302	VS2SC945AP/-1	J	2SC945	AB	D319	RH-EX0310CEZZ	J	Zener Diode, 8.2V	AA
Q303	VS2SC945AP/-1	J	2SC945	AB	D320	RH-EX0310CEZZ	J	Zener Diode, 8.2V	AA
Q304	VS2SC2236Y/-1	J	2SC2236(Y)	AD	D401	RH-DX0446CEZZ	J		AB
Q307	VS2SC945AP/-1	J	2SC945	AB	D407	RH-DX0446CEZZ	J		AB
Q310	VS2SC945AP/-1	J	2SC945	AB	D501	RH-DX0279CEZZ	J		AB
Q409	VS2SC945AP/-1	J	2SC945	AB	D502	RH-DX0127CEZZ	J		AC
Q452	VS2SC945AP/-1	J	2SC945	AB	D506	VHD1SS119//1E	J	1SS119	AA
Q453	VS2SC945AP/-1	J	2SC945	AB	D507	RH-DX0446CEZZ	J		AB
Q601	VS2SC2271E/-1	J	2SC2271(E)	AD	D509	RH-DX0446CEZZ	J		AB
△ Q602	VS2SD1877//1E	J	2SD1877 (14H-SC)	AL	D602	RH-EX0310CEZZ	J	Zener Diode, 8.2V	AA
△ Q602	VS2SD1554//1E	J	2SD1554 (20H-SC)	AL	D603	RH-DX0073CEZZ	J		AD
△ Q602	VS2SD2095//1E	J	2SD2095 (21H-SC)	AN	D604	RH-DX0279CEZZ	J		AB
△ Q603	VS2SA1015Y/1E	J	2SA1015(Y)	AC	△ D606	RH-DX0446CEZZ	J		AB
Q605	VSKRA102M//-1	J	KRA102M	AA	△ D607	RH-EX0340CEZZ	J	Zener Diode, 22V (14H-SC)	AB
△ Q701	VS2SD1884//1E	J	2SD1884	AN	△ D607	RH-EX0336CEZZ	J	Zener Diode, 22V (20H-SC, 21H-SC)	AA
△ Q702	VS2SC945AP/-1	J	2SC945	AB	D610	RH-DX0446CEZZ	J		AB
Q801	VS2SA1015Y/1E	J	2SA1015(Y)	AC	D611	VHD1SS119//1E	J	1SS119	AA
Q802	VS2SA1015Y/1E	J	2SA1015(Y)	AC	D612	VHD1SS119//1E	J	1SS119	AA
Q803	VS2SA1015Y/1E	J	2SA1015(Y)	AC	△ D618	RH-DX0446CEZZ	J		AB
Q804	VS2SC1815GW-1	J	2SC1815(GW)	AB	D619	RH-DX0279CEZZ	J		AB
					D623	RH-EX0310CEZZ	J	Zener Diode, 8.2V	AA
					△ D701	RH-DX0055TAZZ	J		AD
					△ D702	RH-DX0055TAZZ	J		AD
					△ D703	RH-DX0055TAZZ	J		AD
					△ D704	RH-DX0055TAZZ	J		AD

Ref. No.	Part No.	*	Description	Code	Ref. No.	Part No.	*	Description	Code
PWB-A DUNTK8696WEV0/V2/V1 MAIN UNIT (Continued)					COIL AND TRANSFORMERS (Continued)				
DIODES (Continued)									
△ D705	RH-DX0130CEZZ	J		AE	L203	VP-XF1R2K0000	J	Coil, 1.2μH	AB
△ D706	RH-DX0130CEZZ	J		AE	L212	VP-DF270K0000	J	Coil, 27μH	AB
△ D707	RH-DX0164CEZZ	J		AC	L218	VP-XFR56K0000	J	Coil, 0.56μH	AB
△ D708	RH-EX0639CEZZ	J	Zener Diode, 3.9V	AB	L451	VP-XF6R8K0000	J	Coil, 6.8μH	AB
△ D709	RH-DX0302CEZZ	J		AC	L452	VP-XF150K0000	J	Coil, 15μH	AB
△ D710	RH-DX0027CEZZ	J		AE	L601	RCiLZ0004PEZZ	R	Coil (14H-SC)	AN
△ D712	RH-DX0130CEZZ	J		AE	L601	RCiLZ0499CEZZ	J	Coil (20H-SC)	AH
△ D715	RH-EX0323CEZZ	J	Zener Diode, 13V	AB	L601	RCiLZ0007PEZZ	R	Coil (21H-SC)	AK
D732	RH-DX0226CEZZ	J	(14H-SC)	AC	L602	RCiLP0088CEZZ	J	Coil	AG
D732	RH-DX0388CEZZ	J	(20H-SC, 21H-SC)	AE	L609	VP-CF1R5M0000	J	Coil, 1.5μH (14H-SC, 20H-SC)	AB
D733	RH-DX0302CEZZ	J		AC	L609	VP-CF1R0M0000	J	Coil, 1μH (21H-SC)	AB
D805	RH-EX0274CEZZ	J	Zener Diode, 2.2V	AA	L632	RCiLP0050CEZZ	J	Coil	AE
D807	RH-DX0446CEZZ	J		AB	△ L701	RCiLF0073CEZZ	J	Line Filter (14H-SC)	AG
D808	RH-DX0446CEZZ	J		AB	△ L701	RCiLF0007PEZZ	R	Line Filter (20H-SC, 21H-SC)	AL
D809	RH-DX0446CEZZ	J		AB	△ L702	RCiLF0087CEZZ	J	Line Filter (14H-SC)	AL
D810	VHD1SS119//1E	J	1SS119	AA	△ L702	RCiLF0154CEZZ	J	Line Filter (20H-SC, 21H-SC)	AQ
D812	RH-DX0446CEZZ	J		AB	△ L705	VP-CF3R3K0000	J	Coil, 3.3μH	AB
D1004	RH-DX0446CEZZ	J		AB	△ L712	VP-CF330K0000	J	Coil, 10μH (14H-SC)	AB
D1005	RH-DX0446CEZZ	J		AB	△ L712	VP-CF100K0000	J	Coil, 10μH (20H-SC, 21H-SC)	AB
D1024	RH-DX0446CEZZ	J		AB	L901	VP-XF8R2K0000	J	Coil, 8.2μH	AB
D1039	RH-DX0446CEZZ	J		AB	L1005	VP-DF120K0000	J	Coil, 12μH	AB
D1053	RH-EX0297CEZZ	J	Zener Diode, 5.6V	AA	L2304	VP-XF120K0000	J	Coil, 12μH	AB
D1054	RH-DX0446CEZZ	J		AB	L2305	VP-XF150K0000	J	Coil, 15μH	AB
D1057	RH-EX0297CEZZ	J	Zener Diode, 5.6V	AA	L2306	VP-XF120K0000	J	Coil, 12μH	AB
D1058	RH-DX0446CEZZ	J		AB	L2307	VP-XF3R3K0000	J	Coil, 3.3μH	AB
D1060	VHD1SS119//1E	J	1SS119	AA	L2308	VP-XF2R2K0000	J	Coil, 2.2μH	AB
D1061	RH-DX0446CEZZ	J		AB	SF201	RFiLC0308CEZZ	J	Surface Acoustic Wave Filter	AM
D2301	RH-DX0446CEZZ	J		AB	T203	RCiLi0550CEZZ	J	PIF Coil	AD
D2302	RH-DX0446CEZZ	J		AB	T205	RCiLD0228CEZZ	J	P-DET/AFT Coil	AE
△ VA702	RH-VX0033CEZZ	J	Varistor	AD	△ T601	RTRNZ0179CEZZ	J	Horizontal Drive Trans. (14H-SC)	AE
PACKAGED CIRCUITS									
△ PR701	RMPTP0028CEZZ	J	Positive Coefficient Thermistor (14H-SC)	AG	△ T601	RTRNZ0026PEZZ	R	Horizontal Drive Trans. (20H-SC, 21H-SC)	AH
△ PR701	RMPTP0061CEZZ	J	Positive Coefficient Thermistor (20H-SC, 21H-SC)	AV	△ T602	RTRNF0063PEZZ	R	Flyback Trans. (FBT) (14H-SC)	BE
X802	RCRSB0008PEZZ	R	Crystal, 4.43 MHz	AH	△ T602	RTRNF0069PEZZ	R	Flyback Trans. (FBT) (20H-SC, 21H-SC)	BF
X803	RCRSB0009PEZZ	R	Crystal, 3.58 MHz	AL	△ T701	RTRNZ0083PEZZ	R	Power Regulator Trans.	AU
COIL AND TRANSFORMERS									
CF451	RFiLC0150CEZZ	J	Ceramic Filter, 5.5/6.0 MHz Trap	AF	T1001	RCiLB0009PEZZ	R	Oscillation Coil, Sign Position Adjust	AF
CF452	RFiLC0024CEZZ	J	Ceramic Filter, 6.5 MHz Trap	AE					
CF1001	RFiLC0121GEZZ	J	Ceramic Filter, 8 MHz	AD					
CF2301	RFiLC0268CEZZ	J	Ceramic Filter, 6.0 MHz	AD					
CF2302	RFiLC0270CEZZ	J	Ceramic Filter, 5.5 MHz	AD					
CF2308	RFiLA0025CEZZ	J	Ceramic Filter, 12 MHz	AF					

Ref. No.	Part No.	*	Description	Code	Ref. No.	Part No.	*	Description	Code
PWB-A DUNTK8696WEV0/V2/V1 MAIN UNIT (Continued)					CAPACITORS (Continued)				
CONTROLS									
R248	RVR-M4626GEZZ	J	10k(B) RF-AGC	AB	C327	VCQYTA1HM223K	J	0.022 50V Mylar (20H-SC)	AB
R420	RVR-M4626GEZZ	J	10k(B) Sub-Contrast	AB	C328	VCEAGA1CW477M	J	470 16V Electrolytic	AC
R509	RVR-M4616GEZZ	J	220(B) Vertical Size	AB	C329	VCKYMN1CY103N	J	0.01 16V Ceramic	AA
R514	RVR-M4624GEZZ	J	4.7k(B) Vertical Linearity (20H-SC, 21H-SC)	AB	C335	VCKYMN1CY103N	J	0.01 16V Ceramic	AA
R613	RVR-M4626GEZZ	J	10k(B) Horiz. Center	AB	C338	VCKYMN1CY103N	J	0.01 16V Ceramic	AA
△ R711	RVR-M4324CEZZ	J	220(B) 115V Adjust	AC	C380	VCEAGA1HW106M	J	10 50V Electrolytic	AC
CAPACITORS									
C201	VCKYMN1CY103N	J	0.01 16V Ceramic	AA	C382	VCEAGA1HW106M	J	10 50V Electrolytic	AC
C202	VCKYMN1CY103N	J	0.01 16V Ceramic	AA	C383	VCEAGA1HW106M	J	10 50V Electrolytic	AC
C203	VCKYMN1CY103N	J	0.01 16V Ceramic	AA	C384	VCKYMN1CY103N	J	0.01 16V Ceramic	AA
C205	VCFYFA1HA474J	J	0.47 50V M. Polyester	AC	C385	VCEAGA1AW107M	J	100 10V Electrolytic (14H-SC, 20H-SC)	AB
C206	VCQYTA1HM104K	J	0.1 50V Mylar	AC	C385	VCEAGA1HW106M	J	10 50V Electrolytic (21H-SC)	AC
C208	VCEAGA1AW477M	J	470 10V Electrolytic	AC	C386	VCEAGA1HW334M	J	0.33 50V Electrolytic	AA
C209	VCEAGA1HW105M	J	1 50V Electrolytic	AC	C387	VCEAGA1HW106M	J	10 50V Electrolytic	AC
C213	VCKYMN1CY103N	J	0.01 16V Ceramic	AA	C388	VCEAGA1HW106M	J	10 50V Electrolytic	AC
C220	VCSATA1VE225K	J	2.2 35V Tantalum	AC	C404	VCQYTA1HM473K	J	0.047 50V Mylar	AB
C225	VCEAGA1HW105M	J	1 50V Electrolytic	AC	C406	VCQYTA1HM473K	J	0.047 50V Mylar	AB
C226	VCKYMN1CY103N	J	0.01 16V Ceramic	AA	C407	VCKYMN1CY103N	J	0.01 16V Ceramic	AA
C231	VCQYTA1HM104K	J	0.1 50V Mylar	AC	C442	VCEAGA1AW107M	J	100 10V Electrolytic	AB
C232	VCEAGA1AW107M	J	100 10V Electrolytic	AB	C443	VCEAGA1CW476M	J	47 16V Electrolytic	AB
C233	VCEAGA1HW106M	J	10 50V Electrolytic	AC	C451	VCKYMN1CY103N	J	0.01 16V Ceramic	AA
C239	VCQYTA1HM104K	J	0.1 50V Mylar	AC	C455	VCEAGA1CW476M	J	47 16V Electrolytic	AB
C240	VCEAGA1AW477M	J	470 10V Electrolytic	AC	C456	VCEAGA1HW106M	J	10 50V Electrolytic	AC
C242	VCKYD41CY103N	J	0.01 16V Ceramic	AA	C457	VCEAGA1HW106M	J	10 50V Electrolytic	AC
C244	VCCCMN1HH8R2K	J	8.2p 50V Ceramic	AA	C460	VCKYMN1CY103N	J	0.01 16V Ceramic	AA
C249	VCKYMN1CY103N	J	0.01 16V Ceramic	AA	C461	VCEAGA1CW477M	J	470 16V Electrolytic	AC
C250	VCKYMN1CY103N	J	0.01 16V Ceramic	AA	C463	VCEAGA1CW476M	J	47 16V Electrolytic	AB
C259	VCKYMN1CY103N	J	0.01 16V Ceramic	AA	C466	VCEAGA1HW106M	J	10 50V Electrolytic	AC
C269	VCKYMN1CY103N	J	0.01 16V Ceramic	AA	C502	VCKYPA1HB471K	J	470p 50V Ceramic	AA
C300	VCEAGA1HW106M	J	10 50V Electrolytic	AC	C503	VCQYTA1HM272K	J	2700p50V Mylar	AA
C303	VCEAGA1HW105M	J	1 50V Electrolytic (14H-SC, 21H-SC)	AC	C504	VCKYMN1HB102K	J	1000p50V Ceramic	AA
C303	VCEAGA1HW475M	J	4.7 50V Electrolytic (20H-SC)	AB	C505	VCQYTA1HM104K	J	0.1 50V Mylar	AC
C304	VCEAGA1HW225M	J	2.2 50V Electrolytic	AB	C506	VCEAGA1EW108M	J	1000 25V Electrolytic	AD
C307	VCEAGA1HW105M	J	1 50V Electrolytic	AC	C507	VCEAGA1EW227M	J	220 25V Electrolytic	AC
C309	VCQYTA1HM104K	J	0.1 50V Mylar	AC	C508	VCSATA1VE225K	J	2.2 35V Tantalum	AC
C311	VCKYPA2HB102K	J	1000p500V Ceramic	AA	C509	VCQYTA1HM104K	J	0.1 50V Mylar	AC
C312	VCEAGA1CW477M	J	470 16V Electrolytic	AC	C510	VCEAGA1VW477M	J	470 35V Electrolytic	AD
C313	VCEAGA1HW104M	J	0.1 50V Electrolytic	AA	C511	VCKYPA2HB102K	J	1000p500V Ceramic	AA
C314	VCQYTA1HM272K	J	2700p50V Mylar	AA	C512	VCEAGA1HW105M	J	1 50V Electrolytic	AC
C315	VCKYMN1CY103N	J	0.01 16V Ceramic	AA	C514	VCSATA1VE104K	J	0.1 35V Tantalum	AC
C319	VCKYD41HB102K	J	1000p50V Ceramic	AA	C515	VCKYMN1CX472M	J	4700p16V Ceramic	AA
C326	VCEAGA1HW225M	J	2.2 50V Electrolytic (14H-SC, 21H-SC)	AB	C601	VCFYFA1HA334J	J	0.33 50V M. Polyester	AB
C326	VCEAGA1HW106M	J	10 50V Electrolytic (20H-SC)	AC	C602	VCQYTA1HM104K	J	0.1 50V Mylar	AC
C327	VCQYTA1HM103K	J	0.01 50V Mylar (14H-SC, 21H-SC)	AB	C606	VCQYTA1HM222K	J	2200p50V Mylar	AA
					C610	VCFYSB2EB823J	J	0.082 250V M. Polyester	AD
					C611	VCKYPA2HB102K	J	1000p500V Ceramic	AA
					C612	RC-KZ0337CEZZ	J	470p 2kV Ceramic (14H-SC)	AD
					C612	VCKYPH3DB561K	J	560p 2kV Ceramic (20H-SC)	AC
					C612	RC-KZ0040CEZZ	J	820p 2kV Ceramic (21H-SC)	AD

Ref. No.	Part No.	*	Description	Code
PWB-A DUNTK8696WEV0/V2/V1 MAIN UNIT (Continued)				
CAPACITORS (Continued)				
C613	VCFPPD2DB434J	J	0.43 200V M. Polyester (14H-SC)	AF
C613	VCFPPD2DB474J	J	0.47 200V M. Polyester (20H-SC)	AE
C613	VCFPPD2DB564J	J	0.56 200V M. Polyester (21H-SC)	AF
C614	VCQPSC2DA104J	J	0.1 200V Polypro Film (20H-SC, 21H-SC)	AC
C615	VCQPSD2DA224J	J	0.22 200V Polypro Film (14H-SC, 21H-SC)	AD
C615	VCFPPD2DB474J	J	0.47 200V M. Polyester (20H-SC)	AE
C616	VCFPPD3CA682H	J	6800p 1.6kV M. Polyester (14H-SC)	AE
C616	VCFPPD3CA103J	J	0.01 1.6kV M. Polyester (20H-SC, 21H-SC)	AF
C617	VCQYTA1HM104K	J	0.1 50V Mylar	AC
C619	VCEAGA2AW106M	J	10 100V Electrolytic	AC
△ C620	VCEAGA1HW105M	J	1 50V Electrolytic	AC
△ C621	VCEAGA0JW337M	J	330 6.3V Electrolytic	AB
△ C622	VCEAGA1HW105M	J	1 50V Electrolytic	AC
C628	VCKYPA2HB221K	J	220p 500V Ceramic	AA
△ C630	VCKYMN1CY103N	J	0.01 16V Ceramic	AA
C636	VCEAGA1CW476M	J	47 16V Electrolytic	AB
C639	VCKYD41HB391K	J	390p 50V Ceramic	AA
C648	VCEAGA1AW107M	J	100 10V Electrolytic	AB
C649	VCKYMN1CX472M	J	4700p 16V Ceramic	AA
C650	VCEAGA1HW105M	J	1 50V Electrolytic	AC
C662	VCEAGA1HW226M	J	22 50V Electrolytic (14H-SC)	AB
C662	VCEAGA1HW106M	J	10 50V Electrolytic (20H-SC, 21H-SC)	AC
△ C701	RC-FZ016SGEZZ	J	0.47 AC250V Special (14H-SC)	AK
△ C701	RC-FZ008SGEZZ	J	0.47 AC250V Special (20H-SC, 21H-SC)	AD
△ C703	RC-KZ0029CEZZ	J	0.01 AC250V Ceramic	AC
△ C704	RC-KZ0029CEZZ	J	0.01 AC250V Ceramic	AC
△ C705	RC-KZ0029CEZZ	J	0.01 AC250V Ceramic	AC
△ C706	RC-KZ0029CEZZ	J	0.01 AC250V Ceramic	AC
△ C707	RC-EZ0521CEZZ	J	330 400V Electrolytic	AV
△ C708	RC-KZ0029CEZZ	J	0.01 AC250V Ceramic	AC
△ C709	VCEAGA1EW107M	J	100 25V Electrolytic	AD
△ C710	VCKYPA2HB102K	J	1000p 500V Ceramic	AA
△ C711	RC-QZA471TAYJ	J	470p Mylar	AB
△ C712	VCFYHA1HA474J	J	0.47 50V M. Polyester (14H-SC)	AC
△ C712	VCFYHA1HA684J	J	0.68 50V M. Polyester (20H-SC, 21H-SC)	AD
△ C713	VCKYPA2HB102K	J	1000p 500V Ceramic	AA
△ C714	VCQYTA1HM563K	J	0.056 50V Mylar	AB

Ref. No.	Part No.	*	Description	Code
CAPACITORS (Continued)				
△ C715	VCEAGA1HW335M	J	3.3 50V Electrolytic (14H-SC)	AB
△ C715	VCEAGA1HW105M	J	1 50V Electrolytic (20H-SC, 21H-SC)	AC
△ C716	VCEAGA1HW105M	J	1 50V Electrolytic	AC
△ C717	VCQPSC2JA333K	J	0.033 630V Polypro Film	AB
△ C718	VCKYPH3DB561K	J	560p 2kV Ceramic	AC
△ C719	VCQYTA1HM273K	J	0.027 50V Mylar	AB
△ C720	VCEAGA1JW476M	J	47 63V Electrolytic	AB
△ C721	RC-KZ0341CEZZ	J	1000p 2kV Ceramic	AD
△ C723	VCKYPA2HB102K	J	1000p 500V Ceramic	AA
△ C724	RC-KZ0029CEZZ	J	0.01 AC250V Ceramic	AC
△ C725	VCFYFA1HA474J	J	0.47 50V M. Polyester	AC
△ C726	VCKYPA1HB681K	J	680p 50V Ceramic	AA
△ C729	VCEAGA1CW477M	J	470 16V Electrolytic	AC
C731	VCEAGW2CW227M	J	220 160V Electrolytic	AK
C732	RC-KZ0341CEZZ	J	1000p 2kV Ceramic	AD
C733	VCKYPA2HB102K	J	1000p 500V Ceramic	AA
C734	VCEAGA1CW477M	J	470 16V Electrolytic	AC
△ C736	RC-KZ0029CEZZ	J	0.01 AC250V Ceramic	AC
C737	VCEAGH2CW107M	J	100 160V Electrolytic	AE
△ C741	VCKYPA2HB472K	J	4700p 500V Ceramic	AB
△ C742	VCFYFA1HA474J	J	0.47 50V M. Polyester (14H-SC)	AC
△ C742	VCFYFA1HA394J	J	0.39 50V M. Polyester (20H-SC, 21H-SC)	AC
△ C747	RC-KZ0265CEZZ	J	1500p 4kV Ceramic	AE
C811	VCQYTA1HM103K	J	0.01 50V Mylar	AB
C812	VCQYTA1HM103K	J	0.01 50V Mylar	AB
C813	VCQYTA1HM103K	J	0.01 50V Mylar	AB
C815	VCEAGA1HW475M	J	4.7 50V Electrolytic	AB
C817	VCQYTA1HM104K	J	0.1 50V Mylar	AC
C818	VCQYTA1HM104K	J	0.1 50V Mylar	AC
C819	VCCCMN1HH180J	J	18p 50V Ceramic	AA
C820	VCCCMN1HH180J	J	18p 50V Ceramic	AA
C821	VCKYMN1CX472M	J	4700p 16V Ceramic	AA
C822	VCEAGA1HW104M	J	0.1 50V Electrolytic	AA
C823	VCEAGA1CW476M	J	47 16V Electrolytic	AB
C825	VCKYPA1HB102K	J	1000p 50V Ceramic	AA
C826	VCKYPA1HB102K	J	1000p 50V Ceramic	AA
C827	VCKYMN1CY103N	J	0.01 16V Ceramic	AA
C840	VCEAGA1AW226M	J	22 10V Electrolytic	AA
C885	VCEAGA1EW107M	J	100 25V Electrolytic	AD
C900	VCCSMN1HL330J	J	33p 50V Ceramic	AA
C901	VCKYMN1CY103N	J	0.01 16V Ceramic	AA
C903	VCQYTA1HM104K	J	0.1 50V Mylar	AC
C904	VCFYFA1HA224J	J	0.22 50V M. Polyester	AB
C909	VCCCPA1HH470J	J	47p 50V Ceramic	AA
C1001	VCEAGA1HW475M	J	4.7 50V Electrolytic	AB
C1002	VCEAGA1HW475M	J	4.7 50V Electrolytic	AB
C1003	VCEAGA1HW475M	J	4.7 50V Electrolytic	AB
C1004	VCEAGA1CW106M	J	10 16V Electrolytic	AA
C1007	VCQYTA1HM104K	J	0.1 50V Mylar	AC
C1008	VCQYTA1HM104K	J	0.1 50V Mylar	AC

Ref. No.	Part No.	*	Description	Code	Ref. No.	Part No.	*	Description	Code
PWB-A DUNTK8696WEV0/V2/V1 MAIN UNIT (Continued)					RESISTORS				
CAPACITORS (Continued)					R202	VRD-MN2BE682J	J	6.8k 1/8W Carbon	AA
C1009	VCKYMN1HB221K	J	220p 50V Ceramic	AA	R203	VRD-MN2BE472J	J	4.7k 1/8W Carbon	AA
C1011	VCKYMN1HB101K	J	100p 50V Ceramic	AA	R204	VRD-MN2BE220J	J	22 1/8W Carbon	AA
C1013	VCEAGA1HW106M	J	10 50V Electrolytic	AC	R205	VRD-MN2BE151J	J	150 1/8W Carbon	AA
C1014	VCKYMN1HB151K	J	150p 50V Ceramic	AA	R206	VRD-MN2BE471J	J	470 1/8W Carbon	AA
C1015	VCEAGA1HW475M	J	4.7 50V Electrolytic	AB	R207	VRD-RA2EE221J	J	220 1/4W Carbon	AA
C1017	VCQYTA1HM104K	J	0.1 50V Mylar	AC	R208	VRD-MN2BE102J	J	1k 1/8W Carbon	AA
C1022	VCEAGA1EW475M	J	4.7 25V Electrolytic	AA	R209	VRD-MN2BE151J	J	150 1/8W Carbon	AA
C1023	VCKYMN1HB151K	J	150p 50V Ceramic	AA	R211	VRD-MN2BE561J	J	560 1/8W Carbon	AA
C1024	VCKYMN1HB151K	J	150p 50V Ceramic	AA	R214	VRD-MN2BE470J	J	47 1/8W Carbon	AA
C1025	VCKYMN1HB151K	J	150p 50V Ceramic	AA	R215	VRD-MN2BE682J	J	6.8k 1/8W Carbon	AA
C1026	VCKYMN1HB471K	J	470p 50V Ceramic	AA	R217	VRD-MN2BE822J	J	8.2k 1/8W Carbon	AA
C1028	VCQYTA1HM103K	J	0.01 50V Mylar	AB	R223	VRD-MN2BE102J	J	1k 1/8W Carbon	AA
C1030	VCKYMN1HB221K	J	220p 50V Ceramic	AA	R225	VRD-MN2BE223J	J	22k 1/8W Carbon	AA
C1033	VCKYMN1HB221K	J	220p 50V Ceramic	AA	R232	VRD-RA2EE681J	J	680 1/4W Carbon	AA
C1038	VCKYMN1CY103N	J	0.01 16V Ceramic	AA	R233	VRD-RA2EE125J	J	1.2M 1/4W Carbon	AA
C1044	VCKYMN1HB221K	J	220p 50V Ceramic	AA	R236	VRD-MN2BE472J	J	4.7k 1/8W Carbon	AA
C1045	VCKYMN1HB221K	J	220p 50V Ceramic	AA	R237	VRD-MN2BE472J	J	4.7k 1/8W Carbon	AA
C1046	VCKYMN1HB221K	J	220p 50V Ceramic	AA	R238	VRD-MN2BE472J	J	4.7k 1/8W Carbon	AA
C1047	VCKYMN1HB221K	J	220p 50V Ceramic	AA	R240	VRD-MN2BE184J	J	180k 1/8W Carbon	AA
C1048	VCEAGA1HW475M	J	4.7 50V Electrolytic	AB	R241	VRD-MN2BE824J	J	820k 1/8W Carbon	AA
C1049	VCEAGA1HW475M	J	4.7 50V Electrolytic	AB	R244	VRD-MN2BE274J	J	270k 1/8W Carbon	AA
C1052	VCEAGA1AW107M	J	100 10V Electrolytic	AB	R247	VRD-MN2BE123J	J	12k 1/8W Carbon	AA
C1060	VCKYMN1HB221K	J	220p 50V Ceramic	AA	R248	<i>See Controls</i>			
C1062	VCKYMN1CY103N	J	0.01 16V Ceramic	AA	R254	VRD-MN2BE333J	J	33k 1/8W Carbon	AA
C1063	VCKYMN1CY103N	J	0.01 16V Ceramic	AA	R255	VRD-MN2BE473J	J	47k 1/8W Carbon	AA
C1064	VCEAGA1HW335M	J	3.3 50V Electrolytic	AB	R256	VRD-MN2BE104J	J	100k 1/8W Carbon	AA
C1065	VCQYTA1HM103K	J	0.01 50V Mylar	AB	R261	VRD-MN2BE473J	J	47k 1/8W Carbon	AA
C1066	VCCSMN1HL330J	J	33p 50V Ceramic	AA	R263	VRD-MN2BE681J	J	680 1/8W Carbon	AA
C1068	VCQYTA1HM103K	J	0.01 50V Mylar	AB	R301	VRD-MN2BE102J	J	1k 1/8W Carbon	AA
C2301	VCKYMN1HB101K	J	100p 50V Ceramic	AA	R315	VRD-MN2BE682J	J	6.8k 1/8W Carbon	AA
C2316	VCKYMN1HB101K	J	100p 50V Ceramic	AA	R316	VRD-MN2BE103J	J	10k 1/8W Carbon	AA
C2317	VCKYMN1HB101K	J	100p 50V Ceramic	AA	R317	VRD-MN2BE682J	J	6.8k 1/8W Carbon	AA
C2320	VCKYMN1CY103N	J	0.01 16V Ceramic	AA	R320	VRD-MN2BE332J	J	3.3k 1/8W Carbon	AA
C2321	VCKYMN1HB102K	J	1000p 50V Ceramic	AA	R321	VRD-MN2BE333J	J	33k 1/8W Carbon	AA
C2322	VCCCPA1HH101J	J	100p 50V Ceramic	AA	R323	VRD-RM2HD102J	J	1k 1/2W Carbon	AA
C2323	VCCCPA1HH101J	J	100p 50V Ceramic	AA	R336	VRD-MN2BE102J	J	1k 1/8W Carbon	AA
C2324	VCKYMN1CY103N	J	0.01 16V Ceramic	AA	R337	VRD-RA2BE123J	J	12k 1/8W Carbon	AA
C2325	VCCCPA1HH220J	J	22p 50V Ceramic	AA	R340	VRD-MN2BE103J	J	10k 1/8W Carbon	AA
C2326	VCKYMN1HB331K	J	330p 50V Ceramic	AA	R341	VRD-MN2BE392J	J	3.9k 1/8W Carbon	AA
C2327	VCCCPA1HH820J	J	82p 50V Ceramic	AA	R345	VRD-MN2BE273J	J	27k 1/8W Carbon	AA
C2328	VCKYMN1CY103N	J	0.01 16V Ceramic	AA	R348	VRD-MN2BE124J	J	120k 1/8W Carbon	AA
C2329	VCKYMN1CY103N	J	0.01 16V Ceramic	AA	R349	VRD-MN2BE821J	J	820 1/8W Carbon	AA
C2330	VCCCPA1HH101J	J	100p 50V Ceramic	AA	R351	VRD-MN2BE124J	J	120k 1/8W Carbon	AA
C2331	VCCCPA1HH390J	J	39p 50V Ceramic	AA	R352	VRD-MN2BE392J	J	3.9k 1/8W Carbon	AA
					R353	VRD-MN2BE821J	J	820 1/8W Carbon	AA
					R354	VRD-MN2BE273J	J	27k 1/8W Carbon	AA
					R355	VRD-RA2BE561J	J	560 1/8W Carbon	AA
					R356	VRD-MN2BE104J	J	100k 1/8W Carbon	AA
					R401	VRD-RA2EE820J	J	82 1/4W Carbon	AA
					R410	VRD-MN2BE183J	J	18k 1/8W Carbon	AA
					R411	VRD-RA2BE223J	J	22k 1/8W Carbon	AA
					R412	VRD-MN2BE333J	J	33k 1/8W Carbon	AA
					R414	VRD-RA2BE223J	J	22k 1/8W Carbon	AA

Ref. No.	Part No.	★	Description	Code	Ref. No.	Part No.	★	Description	Code
PWB-A DUNTK8696WEV0/V2/V1 MAIN UNIT (Continued)					RESISTORS (Continued)				
RESISTORS (Continued)					RESISTORS (Continued)				
R420	<i>See Controls</i>				R525	VRD-MN2BE392J	J	3.9k 1/8W Carbon (20H-SC, 21H-SC)	AA
R422	VRD-MN2BE823J	J	82k 1/8W Carbon	AA	R526	VRD-MN2BE272J	J	2.7k 1/8W Carbon (14H-SC)	AA
R437	VRD-MN2BE473J	J	47k 1/8W Carbon	AA	R526	VRD-MN2BE332J	J	3.3k 1/8W Carbon (20H-SC, 21H-SC)	AA
R444	VRD-MN2BE221J	J	220 1/8W Carbon	AA	R527	VRD-RA2EE155J	J	1.5M 1/4W Carbon (14H-SC)	AA
R447	VRD-MN2BE221J	J	220 1/8W Carbon	AA	R527	VRD-RA2EE105J	J	1M 1/4W Carbon (20H-SC, 21H-SC)	AA
R453	VRD-RA2EE181J	J	180 1/4W Carbon	AA	R531	VRD-RM2HD182J	J	1.8k 1/2W Carbon (20H-SC, 21H-SC)	AA
R456	VRD-MN2BE680J	J	68 1/8W Carbon	AA	R552	VRD-RA2EE122J	J	1.2k 1/4W Carbon (20H-SC, 21H-SC)	AA
R458	VRD-MN2BE100J	J	10 1/8W Carbon	AA	R601	VRD-RM2HD5R6J	J	5.6 1/2W Carbon	AA
R459	VRD-MN2BE101J	J	100 1/8W Carbon	AA	R608	VRD-RM2HD392J	J	3.9k 1/2W Carbon (14H-SC)	AA
R460	VRD-MN2BE104J	J	100k 1/8W Carbon	AA	R608	VRD-RM2HD472J	J	4.7k 1/2W Carbon (20H-SC, 21H-SC)	AA
R463	VRD-MN2BE181J	J	180 1/8W Carbon	AA	R609	VRS-SV3LB472J	J	4.7k 3W Metal Oxide (14H-SC)	AC
R465	VRD-MN2BE101J	J	100 1/8W Carbon	AA	R609	VRS-SV3LB392J	J	3.9k 3W Metal Oxide (20H-SC, 21H-SC)	AC
R467	VRD-MN2BE221J	J	220 1/8W Carbon	AA	R611	VRW-KQ3NC100J	J	10 7W Cement (14H-SC)	AE
R468	VRD-MN2BE152J	J	1.5k 1/8W Carbon	AA	R611	VRW-KQ4AC120J	J	12 10W Cement (20H-SC, 21H-SC)	AE
R481	VRD-MN2BE561J	J	560 1/8W Carbon	AA	△ R612	RR-XZ0073CEZZ	J	270 1/4W Fuse Resistor (14H-SC)	AB
R482	VRD-MN2BE471J	J	470 1/8W Carbon	AA	△ R612	RR-XZ0020CEZZ	J	39 1/4W Fuse Resistor (20H-SC, 21H-SC)	AB
R483	VRD-MN2BE222J	J	2.2k 1/8W Carbon	AA	R613	<i>See Controls</i>			
R484	VRD-MN2BE472J	J	4.7k 1/8W Carbon	AA	R614	VRD-RA2BE684J	J	680k 1/8W Carbon	AA
R485	VRD-MN2BE122J	J	1.2k 1/8W Carbon	AA	R616	VRD-MN2BE104J	J	100k 1/8W Carbon (14H-SC)	AA
R486	VRD-MN2BE100J	J	10 1/8W Carbon	AA	R616	VRD-MN2BE154J	J	150k 1/8W Carbon (20H-SC, 21H-SC)	AA
R487	VRD-MN2BE680J	J	68 1/8W Carbon	AA	R617	VRD-RM2HD390J	J	39 1/2W Carbon (20H-SC, 21H-SC)	AA
R504	VRD-MN2BE221J	J	220 1/8W Carbon	AA	R618	VRD-RM2HD102J	J	1k 1/2W Carbon	AA
R505	VRD-MN2BE223J	J	22k 1/8W Carbon (14H-SC)	AA	R619	VRD-MN2BE183J	J	18k 1/8W Carbon	AA
R505	VRD-MN2BE273J	J	27k 1/8W Carbon (20H-SC)	AA	△ R620	RR-XZ0035TAZZ	J	22 1/4W Fuse Resistor (14H-SC)	AB
R505	VRD-MN2BE393J	J	39k 1/8W Carbon (21H-SC)	AA	△ R620	RR-XZ0084CEZZ	J	1 1/4W Fuse Resistor (20H-SC)	AB
R506	VRD-MN2BE332J	J	3.3k 1/8W Carbon	AA	R621	VRN-RV3AB1R2J	J	1.2 1W Metal Film (14H-SC)	AB
R508	VRD-MN2BE123J	J	12k 1/8W Carbon	AA	R621	VRN-RV3DB1R8J	J	1.8 2W Metal Film (20H-SC, 21H-SC)	AB
R509	<i>See Controls</i>				R622	VRD-RM2HD223J	J	22k 1/2W Carbon	AA
R510	VRD-RM2HD1R8J	J	1.8 1/2W Carbon	AA	△ R623	VRD-RA2EE125J	J	1.2M 1/4W Carbon	AA
R511	VRD-MN2BE822J	J	8.2k 1/8W Carbon (14H-SC, 20H-SC)	AA	△ R624	VRD-RA2BE274J	J	270k 1/8W Carbon	AA
R511	VRD-MN2BE103J	J	10k 1/8W Carbon (21H-SC)	AA	R627	VRD-RA2BE181J	J	180 1/8W Carbon	AA
R513	VRD-MN2BE102J	J	1k 1/8W Carbon	AA	△ R628	VRD-MN2BE183J	J	18k 1/8W Carbon	AA
R514	<i>See Controls</i>								
△ R515	RR-XZ0035TAZZ	J	22 1/4W Fuse Resistor	AB					
R516	VRD-RM2HD331J	J	330 1/2W Carbon	AA					
R517	VRD-RM2HD222J	J	2.2k 1/2W Carbon (20H-SC, 21H-SC)	AA					
R519	VRD-MN2BE681J	J	680 1/8W Carbon (14H-SC)	AA					
R520	VRD-RA2EE225J	J	2.2M 1/4W Carbon (14H-SC)	AA					
R520	VRD-RA2EE275J	J	2.7M 1/4W Carbon (20H-SC, 21H-SC)	AA					
△ R521	RR-XZ0029CEZZ	J	3.3 1/2W Fuse Resistor	AB					
R525	VRD-MN2BE272J	J	2.7k 1/8W Carbon (14H-SC)	AA					

Ref. No.	Part No.	*	Description	Code	Ref. No.	Part No.	*	Description	Code
PWB-A DUNTK8696WEV0/V2/V1 MAIN UNIT (Continued)					RESISTORS (Continued)				
RESISTORS (Continued)					RESISTORS (Continued)				
△ R629	VRD-MN2BE123J	J	12k 1/8W Carbon	AA	△ R707	VRD-RA2BE270J	J	27 1/8W Carbon (20H-SC, 21H-SC)	AA
△ R630	VRD-MN2BE123J	J	12k 1/8W Carbon	AA	△ R708	VRS-SV3LB124J	J	120k3W Metal Oxide	AC
R634	VRD-RM2HD680J	J	68 1/2W Carbon (14H-SC)	AA	△ R709	VRS-SV3LB562J	J	5.6k 3W Metal Oxide	AB
R634	VRD-RM2HD101J	J	100 1/2W Carbon (20H-SC, 21H-SC)	AA	△ R710	VRD-MN2BE392J	J	3.9k 1/8W Carbon	AA
△ R635	VRD-MN2BE154J	J	150k1/8W Carbon (14H-SC)	AA	△ R711	<i>See Controls</i>			
△ R635	VRD-MN2BE823J	J	82k 1/8W Carbon (20H-SC, 21H-SC)	AA	△ R712	VRD-MN2BE821J	J	820 1/8W Carbon	AA
R640	VRD-RM2HD682J	J	6.8k 1/2W Carbon	AA	△ R713	VRD-RA2EE225J	J	2.2M 1/4W Carbon	AA
R641	VRD-MN2BE273J	J	27k 1/8W Carbon	AA	△ R714	VRD-MN2BE394J	J	390k1/8W Carbon (14H-SC)	AA
R642	VRD-RM2HD222J	J	2.2k 1/2W Carbon	AA	△ R714	VRD-MN2BE474J	J	470k1/8W Carbon (20H-SC, 21H-SC)	AA
R648	VRD-RM2HD1R8J	J	1.8 1/2W Carbon	AA	△ R715	VRD-MN2BE103J	J	10k 1/8W Carbon	AA
△ R649	VRD-MN2BE472J	J	4.7k 1/8W Carbon	AA	△ R716	VRD-RA2BE180J	J	18 1/8W Carbon	AA
R650	VRD-RA2BE332J	J	3.3k 1/8W Carbon (14H-SC)	AA	△ R717	VRD-MN2BE101J	J	100 1/8W Carbon	AA
R650	VRD-RA2BE222J	J	2.2k 1/8W Carbon (20H-SC, 21H-SC)	AA	△ R718	VRN-VV3ABR22J	J	0.22 1W Metal Film	AA
R653	VRD-RA2BE101J	J	100 1/8W Carbon (14H-SC)	AA	△ R719	VRC-UA2HG825K	J	8.2M 1/2W Solid	AA
R653	VRD-RA2BE390J	J	39 1/8W Carbon (20H-SC, 21H-SC)	AA	△ R720	VRC-UA2HG825K	J	8.2M 1/2W Solid	AA
R654	VRD-MN2BE153J	J	15k 1/8W Carbon	AA	△ R721	VRD-RM2HD1R0J	J	1 1/2W Carbon	AA
R659	VRD-MN2BE391J	J	390 1/8W Carbon (14H-SC)	AA	△ R722	VRN-SV2HBR27J	J	0.27 1/2W Metal Film	AA
R659	VRD-MN2BE151J	J	150 1/8W Carbon (20H-SC, 21H-SC)	AA	△ R723	VRS-SV3LB272J	J	2.7k 3W Metal Oxide	AD
R671	VRD-MN2BE332J	J	3.3k 1/8W Carbon	AA	△ R724	VRD-MN2BE102J	J	1k 1/8W Carbon	AA
R674	VRC-MA2HG562K	J	5.6k 1/2W Solid	AA	△ R731	RR-XZ0016CEZZ	J	1 1/2W Fuse Resistor	AB
R682	VRD-MN2BE122J	J	1.2k 1/8W Carbon (20H-SC, 21H-SC)	AA	△ R735	VRD-RM2HD184J	J	180k1/2W Carbon	AA
R683	VRD-MN2BE122J	J	1.2k 1/8W Carbon (20H-SC, 21H-SC)	AA	△ R736	VRD-RM2HD184J	J	180k1/2W Carbon	AA
△ R701	VRW-KQ3HC1R5J	J	1.5 5W Cement	AE	R809	VRD-MN2BE101J	J	100 1/8W Carbon	AA
△ R702	VRW-KQ4AC2R7K	J	2.7 10W Cement	AE	R811	VRD-MN2BE101J	J	100 1/8W Carbon	AA
△ R703	VRS-SV3LB562J	J	5.6k 3W Metal Oxide	AB	R812	VRD-MN2BE101J	J	100 1/8W Carbon	AA
△ R704	VRS-SV3DB150J	J	15 2W Metal Oxide (14H-SC)	AA	R816	VRD-MN2BE102J	J	1k 1/8W Carbon	AA
△ R704	VRN-RV3DB4R7J	J	4.7 2W Metal Film (20H-SC, 21H-SC)	AB	R817	VRD-MN2BE391J	J	390 1/8W Carbon	AA
△ R705	VRN-VV3AB2R2J	J	2.2 1W Metal Film (14H-SC)	AA	R818	VRD-MN2BE391J	J	390 1/8W Carbon	AA
△ R705	VRN-VV3AB3R3J	J	3.3 1W Metal Film (20H-SC, 21H-SC)	AA	R819	VRD-MN2BE391J	J	390 1/8W Carbon	AA
△ R706	VRD-MN2BE184J	J	180k1/8W Carbon (14H-SC)	AA	R825	VRD-MN2BE103J	J	10k 1/8W Carbon	AA
△ R706	VRD-MN2BE224J	J	220k1/8W Carbon (20H-SC, 21H-SC)	AA	R828	VRD-MN2BE184J	J	180k1/8W Carbon	AA
△ R707	VRD-RA2BE390J	J	39 1/8W Carbon (14H-SC)	AA	R829	VRD-MN2BE104J	J	100k1/8W Carbon	AA
					R832	VRD-RA2EE271J	J	270 1/4W Carbon	AA
					R833	VRD-MN2BE223J	J	22k 1/8W Carbon	AA
					R837	VRD-MN2BE102J	J	1k 1/8W Carbon	AA
					R838	VRD-MN2BE102J	J	1k 1/8W Carbon	AA
					R839	VRD-MN2BE102J	J	1k 1/8W Carbon	AA
					R840	VRD-MN2BE821J	J	820 1/8W Carbon	AA
					R841	VRD-MN2BE821J	J	820 1/8W Carbon	AA
					R842	VRD-MN2BE821J	J	820 1/8W Carbon	AA
					R844	VRD-RM2HD471J	J	470 1/2W Carbon	AA
					R849	VRD-MN2BE183J	J	18k 1/8W Carbon	AA
					R892	VRD-RA2BE682J	J	6.8k 1/8W Carbon	AA
					R902	VRD-MN2BE331J	J	330 1/8W Carbon	AA
					R1005	VRD-MN2BE682J	J	6.8k 1/8W Carbon	AA
					R1006	VRD-RA2BE272J	J	2.7k 1/8W Carbon	AA
					R1007	VRD-MN2BE682J	J	6.8k 1/8W Carbon	AA
					R1008	VRD-MN2BE103J	J	10k 1/8W Carbon	AA
					R1017	VRD-RA2BE331J	J	330 1/8W Carbon	AA
					R1019	VRD-MN2BE273J	J	27k 1/8W Carbon	AA
					R1021	VRD-MN2BE472J	J	4.7k 1/8W Carbon	AA

Ref. No.	Part No.	*	Description	Code	Ref. No.	Part No.	*	Description	Code
PWB-A DUNTK8696WEV0/V2/V1 MAIN UNIT (Continued)					RESISTORS (Continued)				
R1025	VRD-RA2BE102J	J	1k 1/8W Carbon	AA	R1125	VRD-RA2BE682J	J	6.8k 1/8W Carbon	AA
R1027	VRD-MN2BE103J	J	10k 1/8W Carbon	AA	R1126	VRD-RA2BE102J	J	1k 1/8W Carbon	AA
R1028	VRD-MN2BE684J	J	680k 1/8W Carbon	AA	R1127	VRD-RA2BE332J	J	3.3k 1/8W Carbon	AA
R1029	VRD-MN2BE333J	J	33k 1/8W Carbon	AA	R1128	VRD-RA2BE273J	J	27k 1/8W Carbon	AA
R1030	VRD-MN2BE333J	J	33k 1/8W Carbon	AA	R1129	VRD-MN2BE104J	J	100k 1/8W Carbon	AA
R1031	VRD-MN2BE153J	J	15k 1/8W Carbon	AA	R1131	VRD-RA2BE101J	J	100 1/8W Carbon	AA
R1032	VRS-VV3DB123J	J	12k 2W Metal Oxide	AA	R1132	VRD-RA2BE103J	J	10k 1/8W Carbon	AA
R1033	VRD-RA2BE103J	J	10k 1/8W Carbon	AA	R2302	VRD-MN2BE222J	J	2.2k 1/8W Carbon	AA
R1039	VRD-MN2BE153J	J	15k 1/8W Carbon	AA	R2305	VRD-MN2BE221J	J	220 1/8W Carbon	AA
R1040	VRD-MN2BE123J	J	12k 1/8W Carbon	AA	R2319	VRD-MN2BE223J	J	22k 1/8W Carbon	AA
R1044	VRD-MN2BE682J	J	6.8k 1/8W Carbon	AA	R2325	VRD-MN2BE102J	J	1k 1/8W Carbon	AA
R1046	VRD-MN2BE682J	J	6.8k 1/8W Carbon	AA	R2326	VRD-MN2BE332J	J	3.3k 1/8W Carbon	AA
R1048	VRD-MN2BE102J	J	1k 1/8W Carbon	AA	R2327	VRD-MN2BE103J	J	10k 1/8W Carbon	AA
R1050	VRD-MN2BE102J	J	1k 1/8W Carbon	AA	R2328	VRD-MN2BE561J	J	560 1/8W Carbon	AA
R1051	VRD-MN2BE332J	J	3.3k 1/8W Carbon	AA	R2329	VRD-MN2BE561J	J	560 1/8W Carbon	AA
R1052	VRD-MN2BE332J	J	3.3k 1/8W Carbon	AA	R2330	VRD-MN2BE102J	J	1k 1/8W Carbon	AA
R1053	VRD-MN2BE332J	J	3.3k 1/8W Carbon	AA	R2331	VRD-MN2BE101J	J	100 1/8W Carbon	AA
R1054	VRD-MN2BE123J	J	12k 1/8W Carbon	AA	R2332	VRD-MN2BE102J	J	1k 1/8W Carbon	AA
R1060	VRD-RM2HD821J	J	820 1/2W Carbon	AA	R2333	VRD-MN2BE391J	J	390 1/8W Carbon	AA
R1062	VRD-RA2EE681J	J	680 1/4W Carbon	AA	R2334	VRD-MN2BE470J	J	47 1/8W Carbon	AA
R1064	VRD-MN2BE682J	J	6.8k 1/8W Carbon	AA	R2335	VRD-MN2BE183J	J	18k 1/8W Carbon	AA
			(20H-SC, 21H-SC)		R2336	VRD-MN2BE561J	J	560 1/8W Carbon	AA
R1066	VRD-MN2BE682J	J	6.8k 1/8W Carbon	AA	R2337	VRD-RA2EE105J	J	1M 1/4W Carbon	AA
R1069	VRD-RA2EE181J	J	180 1/4W Carbon	AA	R2338	VRD-MN2BE103J	J	10k 1/8W Carbon	AA
R1073	VRD-MN2BE102J	J	1k 1/8W Carbon	AA					
R1074	VRD-MN2BE392J	J	3.9k 1/8W Carbon	AA	SWITCHES				
R1077	VRD-MN2BE223J	J	22k 1/8W Carbon	AA	S501	QSW-B0015CEZZ	J	Vertical Center Adjust (20H-SC, 21H-SC)	AC
R1078	VRD-MN2BE822J	J	8.2k 1/8W Carbon	AA	△ S701	QSW-P0588CEZZ	J	Main's Power	AP
R1079	VRD-MN2BE222J	J	2.2k 1/8W Carbon	AA	S1001	QSW-K0079GEZZ	J	Channel Up	AB
R1089	VRD-MN2BE153J	J	15k 1/8W Carbon	AA	S1002	QSW-K0079GEZZ	J	Channel Down	AB
R1090	VRD-MN2BE182J	J	1.8k 1/8W Carbon	AA	S1003	QSW-K0079GEZZ	J	Volume Up	AB
R1091	VRD-MN2BE393J	J	39k 1/8W Carbon	AA	S1004	QSW-K0079GEZZ	J	Volume Down	AB
R1092	VRD-MN2BE153J	J	15k 1/8W Carbon	AA	S1005	QSW-K0079GEZZ	J	Preset	AB
R1093	VRD-MN2BE682J	J	6.8k 1/8W Carbon	AA					
R1094	VRD-MN2BE682J	J	6.8k 1/8W Carbon	AA	MISCELLANEOUS PARTS				
R1095	VRD-MN2BE682J	J	6.8k 1/8W Carbon	AA	CN601	QCNW-0430PEZZ	R	Connecting Wire (20H-SC, 21H-SC)	AC
R1096	VRD-MN2BE682J	J	6.8k 1/8W Carbon	AA	△ F300	QFS-J1521CEZZ	J	IC Protector	AF
R1099	VRD-MN2BE222J	J	2.2k 1/8W Carbon	AA	△ F701	QFS-C3224CEZZ	J	Fuse, T3.15A	AD
R1105	VRD-MN2BE682J	J	6.8k 1/8W Carbon	AA	FB305	RBLN-0037CEZZ	J	Ferrite Bead	AB
R1109	VRD-RA2BE682J	J	6.8k 1/8W Carbon	AA	FB602	RBLN-0037CEZZ	J	Ferrite Bead	AB
R1110	VRD-MN2BE682J	J	6.8k 1/8W Carbon	AA	△ FB702	RBLN-0037CEZZ	J	Ferrite Bead	AB
R1111	VRD-MN2BE682J	J	6.8k 1/8W Carbon	AA	△ FB706	RBLN-0037CEZZ	J	Ferrite Bead	AB
R1114	VRD-MN2BE271J	J	270 1/8W Carbon	AA	FB731	RBLN-0010CEZZ	J	Ferrite Bead	AC
R1116	VRD-MN2BE153J	J	15k 1/8W Carbon	AA	FH701	QFSDH1013CEZZ	J	Fuse Holder, for F701	AC
R1117	VRD-MN2BE683J	J	68k 1/8W Carbon	AA	FH702	QFSDH1014CEZZ	J	Fuse Holder, for F701	AC
R1118	VRD-MN2BE392J	J	3.9k 1/8W Carbon	AA	△ J451	QJAKH0007CEZZ	J	Jack, AV Input/Output	AL
R1119	VRD-MN2BE392J	J	3.9k 1/8W Carbon	AA	P210	QPLGN0241CE04	J	Plug 2-pin, TP210	AA
R1120	VRD-MN2BE392J	J	3.9k 1/8W Carbon	AA	P301	QPLGN0241CEZZ	J	Plug 2-pin, (S2)	AA
R1121	VRD-RA2BE332J	J	3.3k 1/8W Carbon	AA	P501	QPLGN0241CE04	J	Plug 2-pin, TP501	AA
R1123	VRD-MN2BE683J	J	68k 1/8W Carbon	AA	P502	QPLGN0505CEZZ	J	Plug 5-pin, (F)	AB
R1124	VRD-RA2BE682J	J	6.8k 1/8W Carbon	AA					

Ref. No.	Part No.	*	Description	Code
PWB-A DUNTK8696WEV0/V2/V1 MAIN UNIT (Continued)				
MISCELLANEOUS PARTS (Continued)				
P601	QPLGN0207CEZZ	J	Plug 2-pin, H-Size Adj. (20H-SC, 21H-SC)	AA
P602	QPLGN0441CEZZ	J	Plug 4-pin, (H)	AB
△ P711	QPLGN0207CEZZ	J	Plug 2-pin, (G)	AA
△ P712	QPLGN0304CEZZ	J	Plug 3-pin, (A)	AB
P801	QPLGN0541CEZZ	J	Plug 5-pin, (K)	AB
SC1001	QSO CN0685CEZZ	J	Socket 6-pin, (RC)	AC

— End of PWB-A —

**PWB-B DUNTK6851WEB2
CRT SOCKET UNIT (14H-SC)**

TRANSISTORS				
Q851	VS2SC2229O/1E	J	2SC2229(O)	AD
Q852	VS2SC2229O/1E	J	2SC2229(O)	AD
Q853	VS2SC2229O/1E	J	2SC2229(O)	AD
DIODE				
D851	RH-EX0271CEZZ	J	Zener Diode, 2.1V	AA
COIL				
L851	VP-CF681K0000	J	Coil, 680 μ H	AB
CONTROLS				
R853	RVR-B4568CEZZ	J	10k(B) Red Bias	AC
R857	RVR-B5639CEZZ	J	1k(B) Green Drive	AB
R859	RVR-B4568CEZZ	J	10k(B) Green Bias	AC
R863	RVR-B5639CEZZ	J	1k(B) Blue Drive	AB
R865	RVR-B4568CEZZ	J	10k(B) Blue Bias	AC

Ref. No.	Part No.	*	Description	Code
CAPACITORS				
C800	VCQYTA1HM103K	J	0.01 50V Mylar	AB
C851	VCKYPA1HB391K	J	390p 50V Ceramic	AA
C852	VCKYPA1HB331K	J	330p 50V Ceramic	AA
C853	VCKYPA1HB391K	J	390p 50V Ceramic	AA
C854	RC-KZ0016CEZZ	J	0.01 1.5kV Ceramic	AC
C855	VCEAGA2DW106M	J	10 200V Electrolytic	AC
C860	VCKYD41CY103N	J	0.01 16V Ceramic	AA
C861	VCEAGA1CW476M	J	47 16V Electrolytic	AB
C866	VCCSPA2HL121J	J	120p 500V Ceramic	AC

RESISTORS				
R851	VRD-RA2BE122J	J	1.2k 1/8W Carbon	AA
R852	VRD-RA2BE272J	J	2.7k 1/8W Carbon	AA
R855	VRD-RM2HD272J	J	2.7k 1/2W Carbon	AA
R856	VRD-RA2BE561J	J	560 1/8W Carbon	AA
R858	VRD-RA2BE272J	J	2.7k 1/8W Carbon	AA
R860	VRS-VV3AB123J	J	12k 1W Metal Oxide	AA
R861	VRD-RM2HD272J	J	2.7k 1/2W Carbon	AA
R862	VRD-RA2BE391J	J	390 1/8W Carbon	AA
R864	VRD-RA2BE272J	J	2.7k 1/8W Carbon	AA
R866	VRS-VV3AB123J	J	12k 1W Metal Oxide	AA
R867	VRD-RM2HD272J	J	2.7k 1/2W Carbon	AA
R868	VRS-VV3AB123J	J	12k 1W Metal Oxide	AA
R872	VRD-RA2BE561J	J	560 1/8W Carbon	AA
R873	VRD-RA2BE561J	J	560 1/8W Carbon	AA
R874	VRD-RA2BE561J	J	560 1/8W Carbon	AA
R878	VRD-RA2BE222J	J	2.2k 1/8W Carbon	AA

MISCELLANEOUS PARTS				
P851	QPLGN0361CEZZ	J	Plug 3-pin, (H)	AB
P852	QPLGN0561CEZZ	J	Plug 5-pin, (K)	AB
△ SC851	QSOCV0829CEZZ	J	CRT Socket	AK
	QCNW-1239PEZZ	R	Connecting Wire, (K)	AG
	QCNW-1341PEZZ	R	Connecting Wire, (H)	AF

— End of PWB-B —

Ref. No.	Part No.	*	Description	Code	Ref. No.	Part No.	*	Description	Code
PWB-B DUNTK7001WEF3/E8 CRT SOCKET UNIT (20H-SC, 21H-SC)					RESISTORS (Continued)				
TRANSISTORS					R877	VRD-RA2BE560J	J	56 1/8W Carbon	AA
Q851	VS2SC3417//1E	J	2SC3417	AC	R878	VRD-RA2BE222J	J	2.2k 1/8W Carbon	AA
Q852	VS2SC3417//1E	J	2SC3417	AC	MISCELLANEOUS PARTS				
Q853	VS2SC3417//1E	J	2SC3417	AC	P851	QPLGN0461CEZZ	J	Plug 4-pin, (H)	AB
DIODE					P852	QPLGN0561CEZZ	J	Plug 5-pin, (K)	AB
D851	RH-EX0271CEZZ	J	Zener Diode, 2.1V	AA	△ SC851	QSO CV0927CEZZ	J	CRT Socket	AL
COIL					CN851	QCNW-1266PEZZ	R	Connecting Wire, (H)	AF
L851	VP-CF681K0000	J	Coil, 680 μ H	AB	CN852	QCNW-1264PEZZ	R	Connecting Wire, (K)	AG
CONTROLS									
R853	RVR-B4568CEZZ	J	10k(B) Red Bias	AC					
R857	RVR-B5639CEZZ	J	1k(B) Green Drive	AB					
R859	RVR-B4568CEZZ	J	10k(B) Green Bias	AC					
R863	RVR-B5639CEZZ	J	1k(B) Blue Drive	AB					
R865	RVR-B4568CEZZ	J	10k(B) Blue Bias	AC					
CAPACITORS									
C800	VCQYTA1HM103K	J	0.01 50V Mylar	AB					
C851	VCKYPA1HB391K	J	390p 50V Ceramic	AA					
C852	VCKYPA1HB391K	J	390p 50V Ceramic	AA					
C853	VCKYPA1HB391K	J	390p 50V Ceramic	AA					
C854	RC-KZ0150CEZZ	J	1000p3kV Ceramic	AB					
C860	VCKYD41CY103N	J	0.01 16V Ceramic	AA					
C861	VCEAGA1CW106M	J	10 16V Electrolytic	AA					
C865	VCKYPA1HB102K	J	1000p50V Ceramic	AA					
C866	VCEAGA2DW106M	J	10 200V Electrolytic	AC					
RESISTORS									
R851	VRD-RA2BE821J	J	820 1/8W Carbon	AA					
R852	VRD-RA2BE272J	J	2.7k 1/8W Carbon	AA					
R855	VRD-RM2HD272J	J	2.7k 1/2W Carbon	AA					
R856	VRD-RA2BE391J	J	390 1/8W Carbon	AA					
R858	VRD-RA2BE272J	J	2.7k 1/8W Carbon	AA					
R860	VRS-VV3DB123J	J	12k 2W Metal Oxide	AA					
R861	VRD-RM2HD272J	J	2.7k 1/2W Carbon	AA					
R862	VRD-RA2BE471J	J	470 1/8W Carbon	AA					
R864	VRD-RA2BE272J	J	2.7k 1/8W Carbon	AA					
R866	VRS-VV3DB123J	J	12k 2W Metal Oxide	AA					
R867	VRD-RM2HD272J	J	2.7k 1/2W Carbon	AA					
R868	VRS-VV3DB123J	J	12k 2W Metal Oxide	AA					
R872	VRD-RA2BE561J	J	560 1/8W Carbon	AA					
R873	VRD-RA2BE561J	J	560 1/8W Carbon	AA					
R874	VRD-RA2BE561J	J	560 1/8W Carbon	AA					
R875	VRD-RA2BE560J	J	56 1/8W Carbon	AA					
R876	VRD-RA2BE560J	J	56 1/8W Carbon	AA					

— End of PWB-B —

Ref. No. Part No. ★ Description Code

**PWB-C DUNTK8697WEV0/V2/V1
LED, R/C RECEIVER UNIT**

DIODE

D1001 RH-PX0291CEZZ J LED, Red/Green AC

MISCELLANEOUS PARTS

P1005 QPLGN0685CEZZ J Plug 6-pin, (RC) AA
RMC1001 RRMCU0216CEZZ J R/C Receiver AK
LHLDP1042PE00 R LED Holder AG

— End of PWB-C —

MISCELLANEOUS PARTS

CN301 QCNW-1240PEZZ R Connecting Wire, (S2) AE
(14H-SC)
CN301 QCNW-1469PEZZ R Connecting Wire, (S2) AG
(20H-SC, 21H-SC)
SP1 VSP9050PB07WA R Speaker
△ ACC701 QACCZ3003PEZZ R AC Cord AQ
(14H-SC, 21H-SC)
△ ACC701 QACCZ2001PESA R AC Cord AN
(20H-SC)
LHLDK0005PE00 R AC Cord Holder AC

— End of MISCELLANEOUS PARTS —

Ref. No. Part No. ★ Description Code

SUPPLIED ACCESSORIES

ACCESSORIES

QPLGA0011CEZZ J AC Plug Adaptor AF
(14H-SC, 21H-SC)
QANTR0018PEZZ R Rod Antenna AQ
(20H-SC)
QPLGJ0113CEZZ J AC Plug Adaptor AG
(20H-SC)
RRMCG1133PESA R Remote Control Unit AX
TINS-5570PEZZ R Operation Manual AG

ACCESSORIES (Not Replacement Item)

TCADS3004PEZZ - SS List —
(14H-SC, 21H-SC)
TMAPC3936PEZZ - Service Map —
(14H-SC)
TMAPC3938PEZZ - Service Map —
(20H-SC)
TMAPC3937PEZZ - Service Map —
(21H-SC)
UBATU0001MEZZ - Dry Batteries —

— End of SUPPLIED ACCESSORIES —

**PACKING PARTS
(NOT REPLACEMENT ITEM)**

MODEL 14H-SC

SPAKC5955PEZZ - Packing Case —
SPAKP0056PEZZ - Polystyrene Cover —
SPAKX2528PEZZ - Buffer Material —

MODEL 20H-SC

SPAKC5988PEZZ - Packing Case —
SPAKP0055PEZZ - Polystyrene Cover —
SPAKX2533PEZZ - Buffer Material —

MODEL 21H-SC

SPAKC5984PEZZ - Packing Case —
SPAKP0055PEZZ - Polystyrene Cover —
SPAKX2531PEZZ - Buffer Material —

— End of PACKING PARTS —

CABINET PARTS

MODEL 14H-SC

1	CCABA2269WEV0	R	Cabinet Ass'y, Front	BC
1-1	<i>Not Available</i>	-	Cabinet, Front	—
1-2	GCOVA0054PESA	R	LED Cover	AF
1-3	HBDGB0018PESA	R	Badge, "SHARP"	AE
1-4	HDECP0009PESA	R	Decoration Sheet	AE
1-5	JB TN-0172PESA	R	Button, Up/Down	AG
1-6	JB TN-0171PESA	R	Button, Power	AE
1-7	MSPRC0068CEFW	J	Spring, Power Button	AA

2	GCABB2228PEKA	R	Cabinet, Rear	AY
---	---------------	---	---------------	----

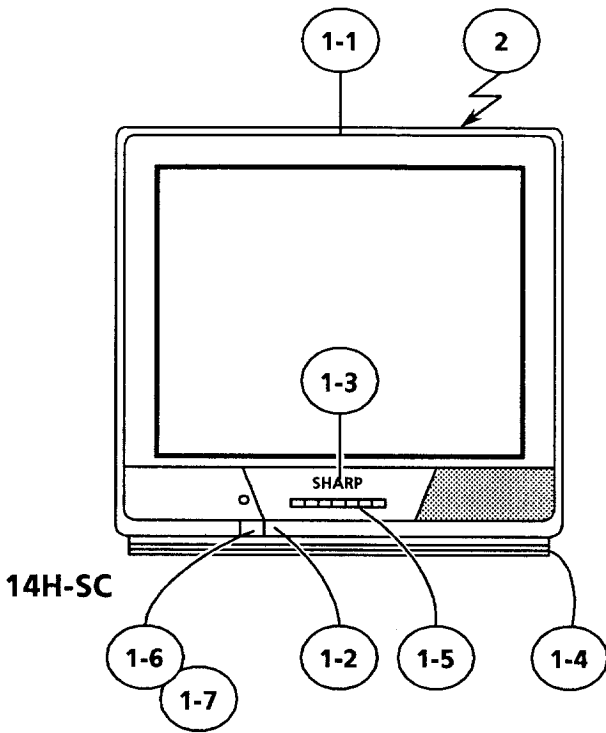

14H-SC

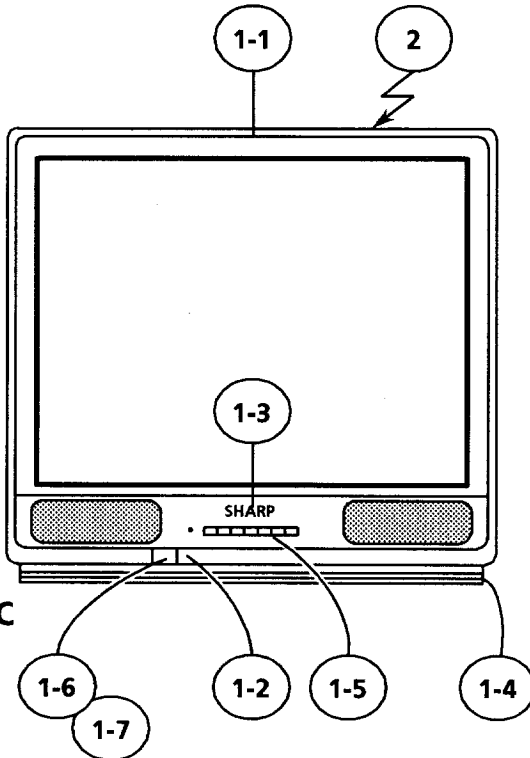

20H-SC

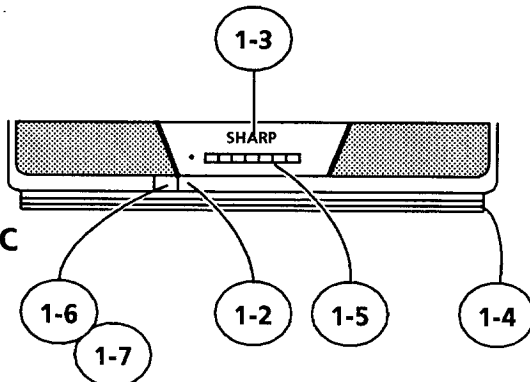

21H-SC

MODEL 20H-SC

1	CCABA2284WEV0	R	Cabinet Ass'y, Front	BG
1-1	<i>Not Available</i>	-	Cabinet, Front	—
1-2	GCOVA0054PESA	R	LED Cover	AF
1-3	HBDGB0019PESA	R	Badge, "SHARP"	AD
1-4	HDECP0010PESA	R	Decoration Sheet	AF
1-5	JB TN-0172PESB	R	Button, Up/Down	AG
1-6	JB TN-0177PESA	R	Button, Power	AG
1-7	MSPRC0068CEFW	J	Spring, Power Button	AA

2	CCABB2239WEV0	R	Cabinet Ass'y, Rear	BD
---	---------------	---	---------------------	----

MODEL 21H-SC

1	CCABA2279WEV0	R	Cabinet Ass'y, Front	BG
1-1	<i>Not Available</i>	-	Cabinet, Front	—
1-2	GCOVA0054PESA	R	LED Cover	AF
1-3	HBDGB0019PESA	R	Badge, "SHARP"	AD
1-4	HDECP0010PESA	R	Decoration Sheet	AF
1-5	JB TN-0172PESA	R	Button, Up/Down	AG
1-6	JB TN-0173PESA	R	Button, Power	AG
1-7	MSPRC0068CEFW	J	Spring, Power Button	AA

2	CCABB2239WEV0	R	Cabinet Ass'y, Rear	BD
---	---------------	---	---------------------	----

— End of CABINET PARTS —